

---

ophthalmologie  
ophthalmology  
oftalmología  
ophthalmologie  
oftalmologia

nopa<sup>®</sup> instruments

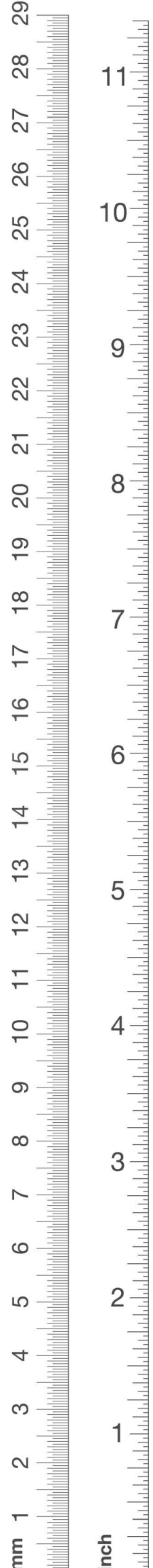



Dies ist unser Katalog, er bleibt unser ausschließliches Eigentum. Es gelten unsere allgemeinen Lieferbedingungen. Sie finden diese auf unserer Internetseite: [www.nopa-instruments.com](http://www.nopa-instruments.com).

This is our Catalogue. It remains our exclusive property. Please find our "General Terms of Sale" on our corporate website: [www.nopa-instruments.com](http://www.nopa-instruments.com).

Esto es nuestro catálogo queda nuestra propiedad. Nuestras condiciones generales de venta se encuentran en nuestra página web: [www.nopa-instruments.com](http://www.nopa-instruments.com).

Voilà notre catalogue et il demeure notre propriété. Veuillez consulter nos conditions générales de vente sur notre page Internet: [www.nopa-instruments.com](http://www.nopa-instruments.com).

Questo è nostro catalogo e rimane nostra proprietà. Trovano applicazione le nostre condizioni generali di fornitura, che sono disponibili sul nostro sito: [www.nopa-instruments.com](http://www.nopa-instruments.com).

Modelländerungen vorbehalten. Nachdruck, auch auszugsweise, verboten.  
Change of design and pattern reserved. Re-printing, even in extracts, not permitted.  
Nos reservamos el derecho de modificaciones sin aviso previo. Reimpresión, también parcialmente, está prohibido.  
Tous droits réservés aux changements de modèle. Réimprimer, également partiellement, est interdit.  
Noi riserviamo il diritto di effettuare delle modificazioni. Ristampa di divieto anche parziale.



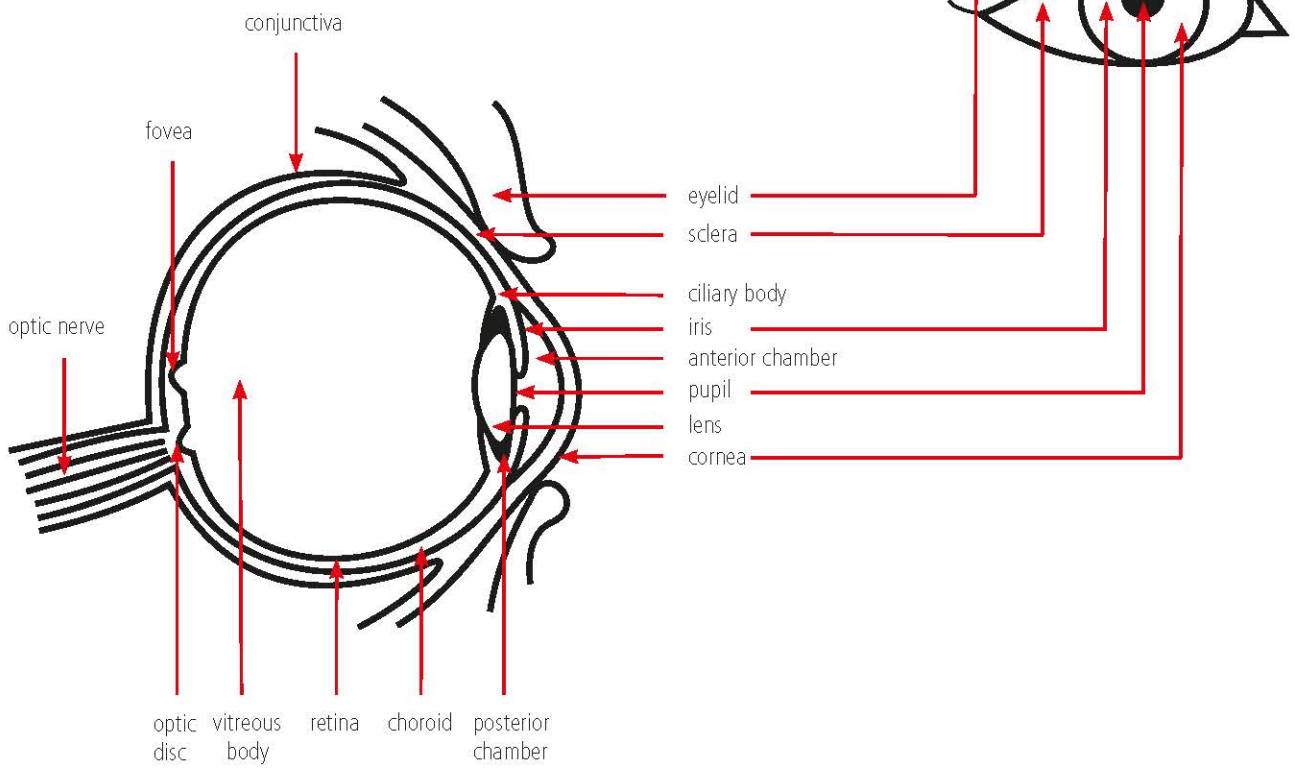

CATALOGUES

Bitte fordern Sie unsere  
entsprechenden Kataloge an.

Please request for our  
appropriate catalogues.

Por favor pidan por nuestros  
catálogos apropiados.

Veuillez demander nos  
catalogues appropriés.

Vogliate richiedere i nostri  
cataloghi adatti.

>> Unser Lieferprogramm

Allgemeinchirurgie  
Gynäkologie, Geburtshilfe und Urologie  
Plastische Chirurgie und HNO  
Thorax, Herz und Gefäßchirurgie  
Neurochirurgie  
Ophthalmologie  
Endoskopie  
Container und Sterilisation  
Dental und Oral

>> Our product range

General Surgery  
Gynecology, obstetrics and urology  
Plastic Surgery and ENT  
Thoracic and cardiovascular surgery  
Neurosurgery  
Ophthalmology  
Endoscopy  
Container and Sterilization  
Dental and Oral

>> Nuestra gama  
de productos

Cirugía general  
Ginecología, obstetricia y urología  
Cirugía plástica y ORL  
Cirugía torácica y cardiovascular  
Neurocirugía  
Oftalmología  
Endoscopia  
Contenedor y esterilización  
Odontología y oral

>> Notre gamme

Chirurgie générale  
Gynécologie, obstétrique et urologie  
Chirurgie plastique et ORL  
Chirurgie thoracique et cardiovasculaire  
Neurochirurgie  
Ophtalmologie  
Endoscopie  
Conteneur et stérilisation  
Dental et Oral

>> Nostro programma  
di produzione

Chirurgia generale  
Ginecologia, ostetricia e urologia  
Chirurgia plastica ed ORL  
Chirurgia toracica e cardiovascolare  
Neurochirurgia  
Oftalmologia  
Endoscopia  
Contentitore e sterilizzazione  
Odontoiatria e Orale

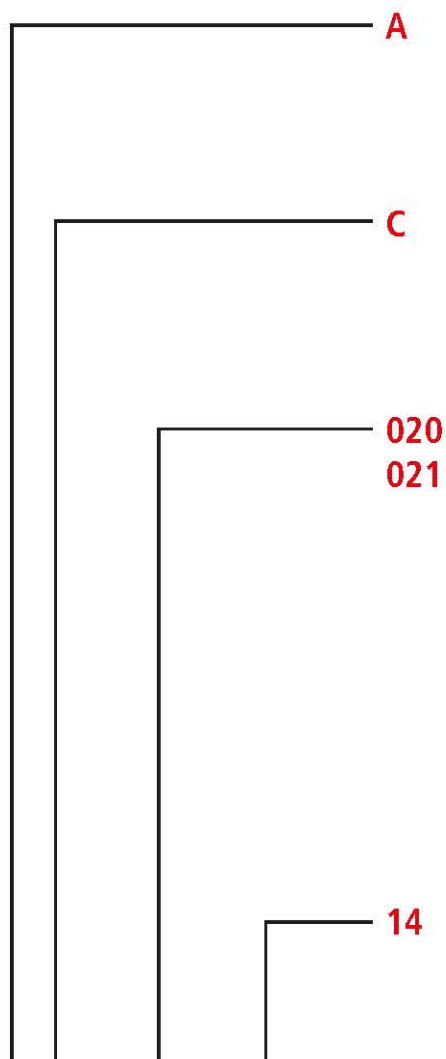

Artikelcode **AC 020/14**

#### Allgemeines Instrumentarium

General Instruments  
Instrumental Général  
Instruments Générales  
Strumenti generali

#### Scheren

Scissors  
Tijeras  
Ciseaux  
Forbici

#### Fortlaufende Nummern

Gerade Ziffer = gerades Instrument  
Ungerade Ziffer = gebogenes Instrument

#### Continuous number

Even number = straight instrument  
Odd number = curved instrument

#### Número de orden

números pares = instrumento derecho  
números impares = instrumento curvado

#### Numéros d'ordre

numéro pair = instrument droit  
numéro impair = instrument courbe

#### Numeri progressivi

numero pari = strumento retto  
numero dispari = strumento curvo

#### Länge oder Figur

Length or Figure  
Longitud o figura  
Longueur ou figure  
Lunghezza o figura

INDEX SETS

ZS 160/00	>> Notfall • Emergency • emergencia • urgence • emergenza	11-16
ZS 160/05	>> Fremdkörper • Foreign Body • cuerpo extraño • corps étranger • corpo estraneo	17
ZS 160/10	>> Nahtentfernung • Stitch Removal • retiro de suturas • enlèvement de suture • togliere la sutura	18
ZS 160/15	>> Strabismus / Muskel • Strabismus / Muscle • estrabismo / musculo • strabisme / muscle • strabismo / muscolo	19-22
ZS 160/20	>> Chalazion • Chalazion • chalazión • chalazion • calazio	23-24
ZS 160/25	>> Enukleation • Enucleation • enucleación • énucléation • enucleazione	25-28
ZS 160/30	>> Glaukom • Glaucoma • glaucoma • glaucome • glaucoma	29-32
ZS 160/35	>> Katarakt E.C. • Cataract E.C. • catarata E.C. • cataracte E.C. • cataratta E.C.	33-38
ZS 160/40	>> Katarakt Linse • Cataract Phacoemulsification • catarata facoemulsificación • cataracte phacoémulsification • cataratta facoemulsificazione	39-44
ZS 160/45	>> Keratoplastik • Keratoplasty • queratoplastía • kératoplastie • cheratoplastica	45-48
ZS 160/50	>> Keratomie astigmatisch • Astigmatic Keratotomy • queratoplastía astigmatismo • kératotomie astigmaté • cheratotomia astigmatica	49-50
ZS 160/55	>> Netzhautablösung • Retinal Detachment • desprendimiento de retina DR • décollement de la rétine • distacco della retina	51-56
ZS 160/60	>> Lid-Konjunktiva • Lid-Conjunctiva • conjunctiva • paupière-conjonctive • congiuntiva	57-60
ZS 160/65	>> Pterygium • Pterygium • pterigión • ptérygion • pterigio	61-62
ZS 160/70	>> Dacryocystorhinostomie • Dacryocystorhinostomy • dacriocistorinostomia • dacryocystorhinostomie • dacriocistorinostomia	63-66
ZS 160/75	>> Lasik • Lasik • lasik • lasik • lasik	67-68
ZS 160/80	>> Radiäre Keratotomie • Radiale Keratotomy • queratotomía radial • kératotomie radiale • cheratotomia radiale	69-70
ZS 160/85	>> Vitrektomie (Pars Plana) • Vitrectomy (Pars Plana) • vitrectomía pars-plana • vitrectomie (pars plana) • vitrectomia pars-plana	71-74

## INDEX INSTRUMENTS

>> Klemmen • Hemostats • Pinzas hemostáticas Pincas hémostatiques • Pinze emostatiche	75-80	AA
>> Pinzetten • Forceps • Pinzas • Pincas • Pinze	81-98	AB
>> Scheren • Scissors • Tijeras • Ciseaux • Forbici	99-118	AC
>> Skalpelle • Scalpels • Bisturíes • Bistouris • Bisturi	119-124	AD
>> Naht • Suture • Sutura • Suture • Sutura	125-134	AE
>> Wundhaken • Retractors • Separadores • Ecarteurs • Divaricatori	135-140	AK
>> Diagnostik • Diagnostics • Diagnóstico • Diagnostic • Diagnostica	141-144	AR
>> Ophthalmologie • Ophthalmology • Oftalmología Ophtalmologie • Oftalmologia	145-206	KP
>> Endoskopie • Endoscopy • Endoscopia • Endoscopie • Endoscopia	207-210	XR

## KYE

- >> Bitte fordern Sie unseren Spezialkatalog für Sterilisationscontainer an.
- >> Please request for our special catalogue for Sterilization Containers.
- >> Por favor pida por nuestro catálogo especial de contenedores de esterilización.
- >> Nous vous prions de demander notre catalogue spécial des conteneurs de stérilisation.
- >> Chieda prego il nostro catalogo per contenitori di sterilizzazione.





Contents:		Qty
AA 060/03	DIEFFENBACH BULLDOG CLAMPS STR 3,5 CM	2
AA 150/12	HALSTED-MOSQUITO FCPS STR 12,5 CM	2
AA 151/12	HALSTED-MOSQUITO FCPS CVD 12,5 CM	2
AA 711/09	JONES TOWEL FORCEPS 9,0 CM	2
AB 710/10	GRAEFE IRIS FORCEPS STR SERR. 10,0 CM	1
AB 734/01	BONN IRIS FORCEPS W.GUIDE PIN 1X2T. 7,0 CM	1
AB 738/08	BISHOP-HARMAN IRIS FORCEPS 1X2 T. 8,5 CM	1
AB 750/07	BARRAQUER-KATZIN FIX.FCPS 1X2 T. 7,0 CM	1
AB 796/02	LESTER FIXATION FORCEPS 1X2 TEETH 9,0 CM	1
AB 816/01	CASTROVIEJO SUTURE FORCEPS 0,12 MM 10,0 CM	2
AB 820/10	KELMAN-MCPHERSON TYING FORCEPS 10,0 CM	1
AB 828/10	PAUFIQUE SUTURE FORCEPS 1X2 TEETH 10,0 CM	1
AC 431/08	MOD.BONN SCISSORS CVD 8,0 CM	1
AC 466/10	IRIS SCISSORS STR W LARGE BOWS 10,0 CM	1
AC 475/11	STEVENS TENOTOM.SCS.CVD POINTED 11,5 CM	1
AC 768/05	BARRAQUER EYE SCISSORS 5,5 CM 5 MM	1
AC 782/11	WESTCOTT TENOTOMY SCISSORS BLUNT 11,0 CM	1
AC 797/01	WESTCOTT STRABISMUS SCS STR SHARP 11,5 CM	1
AD 540/00	RAZER BLADES, PACKING UNIT 10 PIECES	1
AD 550/09	BLADE BREAKER 9.0 CM DIA 5,5 MM	1
AE 600/10	BARRAQUER-TROUTMAN MICRO-NH STR RA 10,0 CM	1
AE 602/10	BARRAQUER-TROUTMAN MICRO-NH STR 10,0 CM	1
AE 660/14	CASTROVIEJO NH STR RA SMOOTH 14,0 CM	1
AK 090/10	DESMARRES RETRACTOR 10 MM 13,0 CM	1
AK 090/12	DESMARRES RETRACTOR 12 MM 13,0 CM	1
AK 090/14	DESMARRES RETRACTOR 14 MM 13,0 CM	1
AR 250/15	MEASURING INSTRUMENT 15,0 CM	1
AR 282/20	CASTROVIEJO CIRCLE 8,0 CM STRAIGHT	1
KP 002/12	JAMESON MUSCLE HOOK 12,0 CM	1
KP 010/14	GASS RETINAL DETACHMENT HOOK 14,0 CM	1
KP 015/02	GRAEFE STRABISMUS HOOK #2 14,0 CM	1
KP 018/12	STEVENS TENOTOMY HOOK 12,0 CM	1
KP 023/01	FIXATION HOOK RIGHT 11,0 CM	1
KP 150/05	BARRAQUER-COLIBRI EYE SPECULA 5,0 MM 3,0 CM	1
KP 150/10	BARRAQUER-COLIBRI EYE SPECULA 10,0 MM 3,0 CM	1
KP 154/04	BARRAQUER PHACO EYE SPECULA 4,0 CM	1
KP 212/08	LIEBERMAN EYE SPECULA 15,0 MM 8,0 CM	1
KP 280/14	SCHOCKET SCLERAL DEPRESSOR 14,0 CM	1
KP 542/01	SCHIOETZ TONOMETER STRAIGHT SCALE	1
KP 700/00	BISHOP-HARMON ANTERIOR CHAMBER	1
KP 731/27	SAUTTER AIR INJECTION CANNULA 27G 3,5 CM	1
SK 305/05	WIRE BASKET, 485 X 255 X 50 MM	1

Sterilization Container KYE 200/61, if required

Irispinzetten  
Iris Forceps  
Pinzas para iris  
Pinces à iris  
Pinze per iride

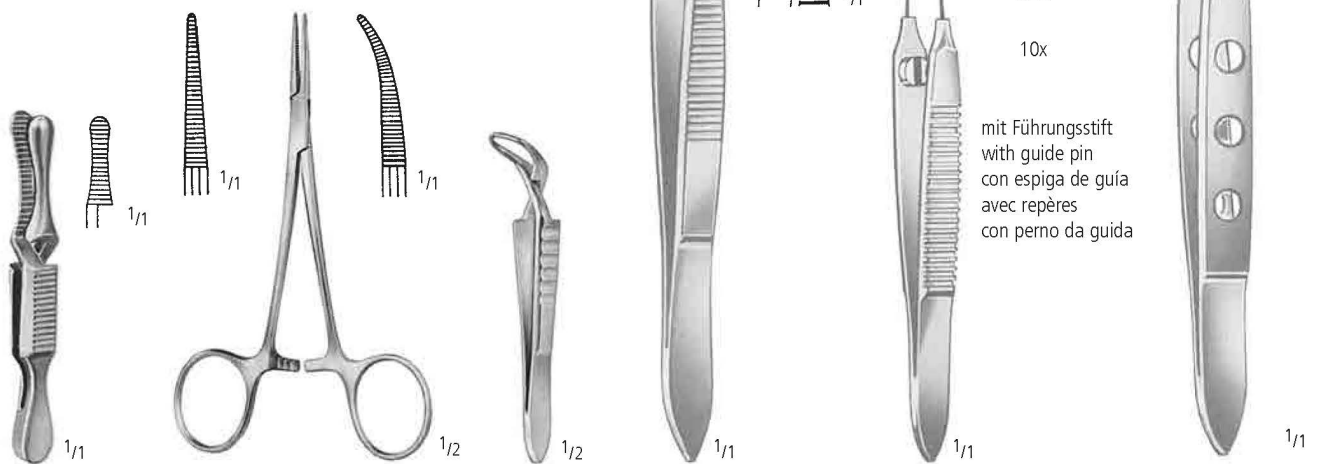

**DIEFFENBACH**

AA 060/03  
3,5 cm/1 1/2"

**HALSTED-MOSQUITO**

AA 150/12 AA 151/12  
12,5 cm/5"

**JONES**

AA 711/09  
9,0 cm/3 1/2"

**GRAEFE**

AB 710/10  
10,0 cm/4"

**MOD. BONN 1:2**

AB 734/01  
7,0 cm/2 3/4"

**BISHOP-HARMAN 1:2**

AB 738/08  
8,5 cm/3 1/3"

mit Führungsstift  
with guide pin  
con espiga de guía  
avec repères  
con perno da guida

10x

**BARRAQUER-KATZIN 1:2**

(Colibri)  
AB 750/07  
7,0 cm/2 3/4"

**LESTER**

AB 796/02  
9,0 cm/3 1/2"

**CASTROVIEJO 1:2**

AB 816/01  
0,12 mm  
10,0 cm/4"

**KELMAN-McPHERSON 1:2**

AB 820/10  
10,0 cm/4"

**PAUFIQUE 1:2**

AB 828/10  
10,0 cm/4"



mit großen Ringen  
with large bows  
con anillos grandes  
avec grands anneaux  
con anelli grandi

Sehnenscheren  
Tenotomy Scissors  
Tijeras para tenotomía  
Ciseaux à ténatomie  
Forbici per tenotomia

spitz pointed  
agudas  
pointues  
acuta

gebogen  
curved  
curvas  
courbes  
curve

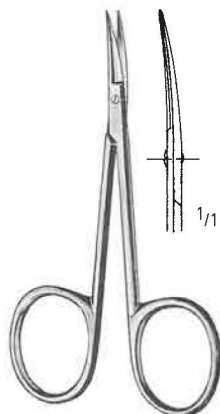

**MOD. BONN**  
AC 431/08  
8,0 cm/3"



AC 466/10  
10,0 cm/4"

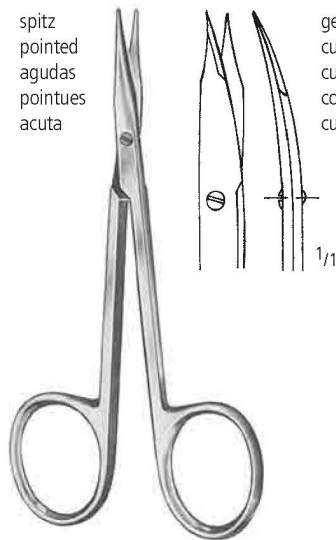

**STEVENS**  
AC 475/11  
11,5 cm/4 1/2"

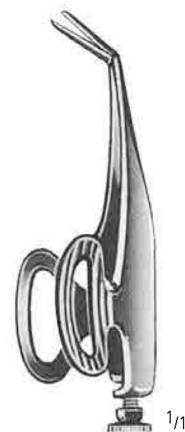

**BARRAQUER**  
5,5 cm/2 1/4"  
5 mm AC 768/05

RASIERKLINGEN, VERPACKUNGSEINHEIT 10 STCK  
RAZOR BLADES, PACKING UNIT 10 PIECES  
HOJAS DE AFEITAR, UNIDAD DE VENTA 10 PZ  
LAMES DE RASOIR, UNITÉ À 10 PIÈCES  
LAMETTE DA BARBA, UNITÀ DI VENDITA 10 PZ

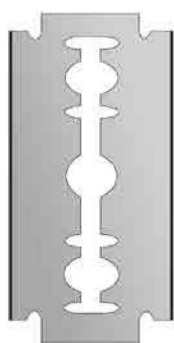
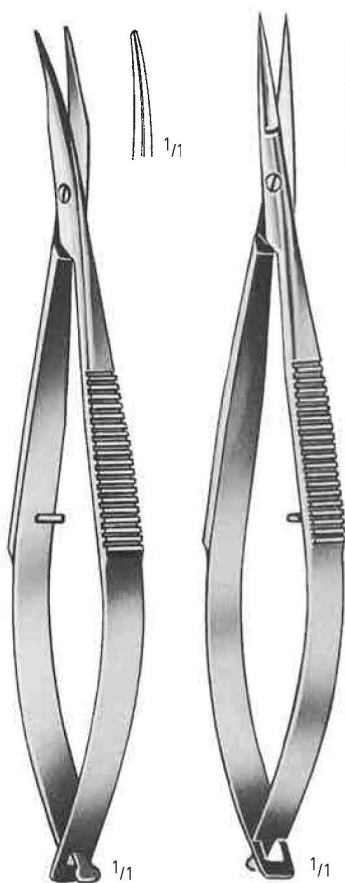

AD 540/00

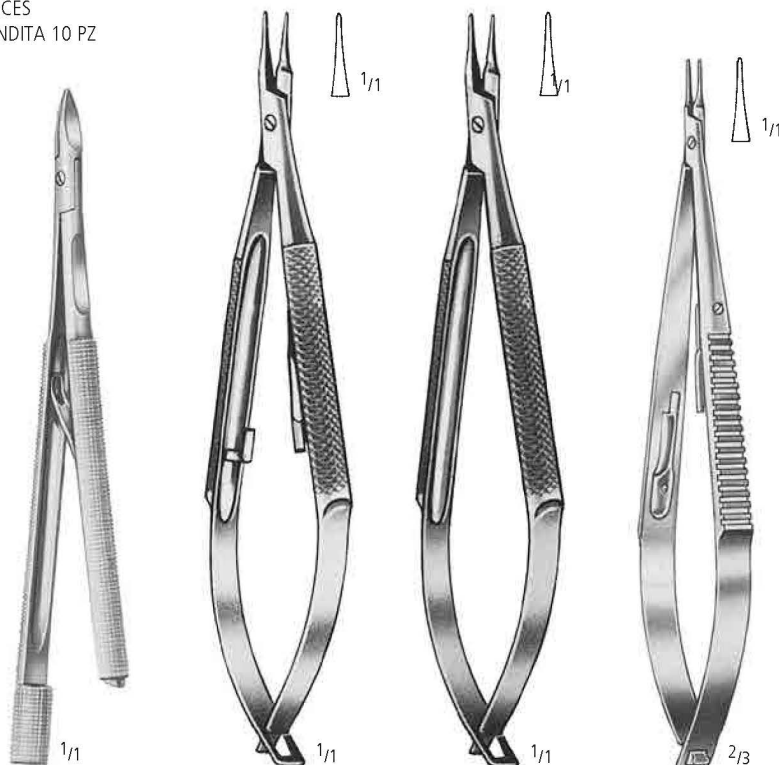

**WESTCOTT**  
AC 782/11  
11,0 cm/4 1/3"

**WESTCOTT**  
AC 797/01  
11,5 cm/4 1/2"

**TROUTMAN-CHRIS**  
AD 550/09  
Ø 5,5 mm  
9,0 cm/3 1/2"

**BARRAQUER-TROUTMAN**  
AE 600/10  
10,0 cm/4"

**BARRAQUER-TROUTMAN**  
AE 602/10  
10,0 cm/4"

**CASTROVIEJO**  
AE 660/14  
14,0 cm/5 1/2"



AK 090/10  
10 mm

AK 090/12  
12 mm

AK 090/14  
14 mm

**DESMARRES**  
13,0 cm/5"



Messbereich 20 mm  
measuring range 20 mm  
campo de medición 20 mm  
étendue de mesurage 20 mm  
ampiezza di misura 20 mm



**CASTROVIEJO**  
AR 282/20  
8,0 cm/3"

AR 250/15  
15,0 cm/6"

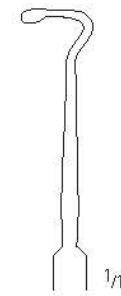

**JAMESON**  
KP 002/12  
12,0 cm/4<sup>3</sup>/<sub>4</sub>"

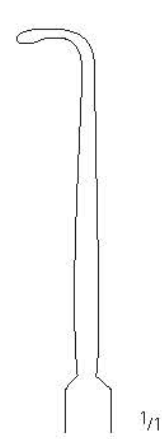

**GRAEFE**  
KP 015/02  
14,0 cm/5<sup>1</sup>/<sub>2</sub>"  
Fig. 2

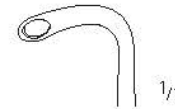

**GASS**  
KP 010/14  
14,0 cm/5<sup>1</sup>/<sub>2</sub>"

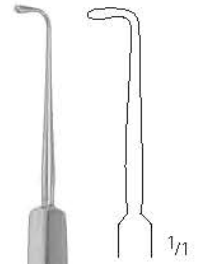

**STEVENS**  
KP 018/12  
12,0 cm/4<sup>3</sup>/<sub>4</sub>"

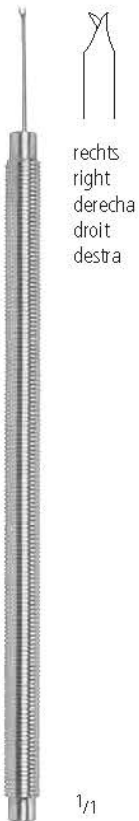

rechts  
right  
derecha  
droit  
destra

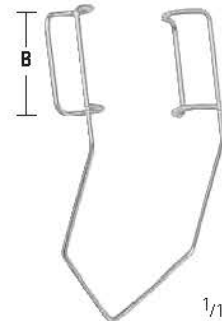

**BARRAQUER-COLIBRI**  
**B**

Frühgeborene KP 150/05  
Premature infant  
Parto prematuro 3,0 cm/1<sup>1</sup>/<sub>4</sub>"  
Accouchement prématuré  
Parto prematuro

Kind  
Child KP 150/10  
Niños 3,0 cm/1<sup>1</sup>/<sub>4</sub>"  
Enfants  
Bambini

KP 023/01  
11,0 cm/4<sup>1</sup>/<sub>2</sub>"



**BARRAQUER PHAKO**  
KP 154/04  
4,0 cm/1<sup>1</sup>/<sub>2</sub>"



**LIEBERMAN**  
KP 212/08  
8,0 cm/3<sup>1</sup>/<sub>4</sub>"  
**B = 15 mm**



**SCHOCKET**  
KP 280/14  
14,0 cm/5 1/2"



gerade Skala  
straight scale  
graduado recto  
échelle droite  
scala retta

**SCHIOETZ**  
KP 542/01  
13,0 cm/5"

Spezifikation Nr. 5, geeicht  
Specification No. 5, calibrated  
Especificación No. 5, calibrada  
Spécification No. 5, calibrée  
Specificca No. 5, calibrata

Set komplett  
Set complete  
Juego completo  
Jeu complet  
Set completo

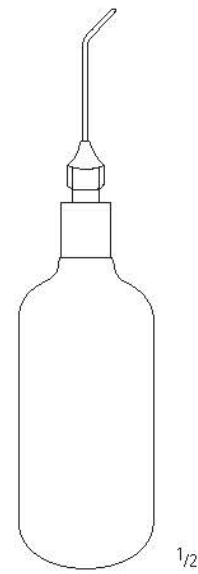

**BISHOP-HARMON**  
KP 700/00

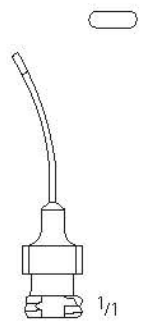

**SAUTTER**  
KP 731/27  
3,5 cm/1 1/2"  
27G

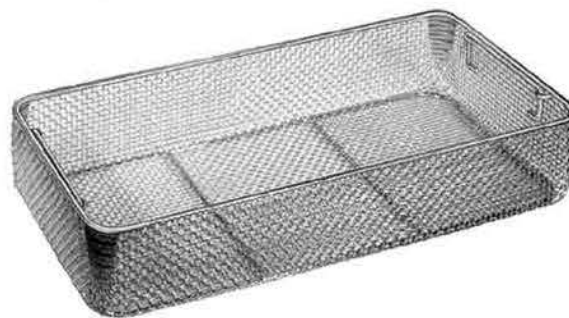

L(mm)	B(mm)	H(mm)	
485	255	50	SK 305/05



Contents:

Qty

<b>KP 150/15</b>	BARRAQUER-COLIBRI EYE SPECULA 15 MM 4,0 CM	1
<b>KP 350/12</b>	FOREIGN BODY INSTRUMENT	1
<b>KP 415/10</b>	MEYHOEFER CHALAZION CURETTE	1
<b>SX 432/01</b>	SILICON MAT 275 X 125 MM	1

Sterilization container KYE 351/01, if required

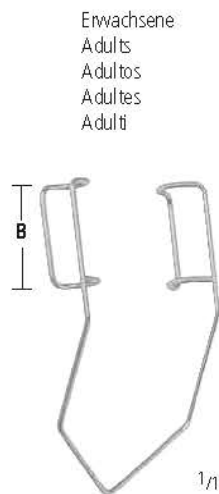

**BARRAQUER-COLIBRI**  
**B**  
15 mm KP 150/15  
4,0 cm/1 1/2"

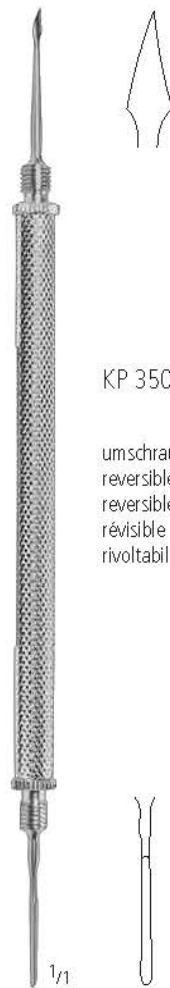

**MEYHOEFER**  
13,0 cm/5"



L(mm)	B(mm)	
275	125	SX 432/01

Contents:		Qty
<b>AB 750/07</b>	BARRAQUER-KATZIN FIX.FCPS 1X2 T. 7,0 CM	1
<b>AC 779/01</b>	GILLS-WELSH CAPSULOTOMY SCISSORS 8,5 CM	1
<b>KP 150/15</b>	BARRAQUER-COLIBRI EYE SPECULA 15 MM 4,0 CM	1
<b>SX 432/01</b>	SILICON MAT 275X125 MM	1

Sterilization container KYE 351/01, if required

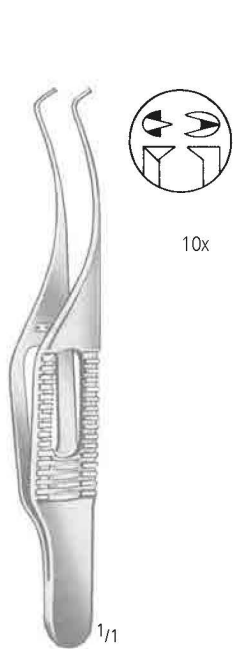

**BARRAQUER-KATZIN 1:2  
(Colibri)**  
AB 750/07  
7,0 cm/2<sup>3</sup>/<sub>4</sub>"



**GILLS-WELSH**  
AC 779/01  
8,5 cm/3<sup>1</sup>/<sub>3</sub>"

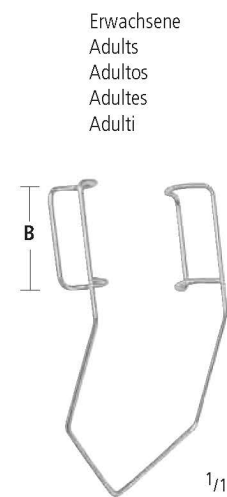

**BARRAQUER-COLIBRI**  
**B**  
15 mm KP 150/15  
4,0 cm/1<sup>1</sup>/<sub>2</sub>"



L(mm)	B(mm)	
275	125	SX 432/01



Contents:		Qty
AA 060/03	DIEFFENBACH BULLDOG CLAMPS STR 3,5 CM	1
AA 114/10	HARTMANN FORCEPS STR 10,0 CM	1
AA 751/13	BACKHAUS TOWEL FORCEPS 13,0 CM	1
AB 734/01	BONN IRIS FORCEPS W.GUIDE PIN 1X2T. 7,0 CM	1
AB 816/01	CASTROVIEJO SUTURE FORCEPS 10,0 CM	2
AB 828/10	PAUFIQUE SUTURE FORCEPS 1X2 TEETH 10,0 CM	1
AB 835/09	BERENS MUSCLE CLAMP 8,5 CM 5 TEETH WITH 1	
AC 450/10	IRIS SCISSORS STR SH/SH 10,5 CM	1
AC 475/11	STEVENS TENOTOM.SCS.CVD POINTED 11,5 CM	1
AC 780/11	WESTCOTT TENOTOMY SCS. POINTED 11,0 CM	1
AC 797/01	WESTCOTT STRABISMUS SCS STR SHARP 11,5 CM	1
AE 660/14	CASTROVIEJO NH STR RA SMOOTH 14,0 CM	1
AE 661/14	CASTROVIEJO NH CVD RA SMOOTH 14,0 CM	1
AR 282/20	CASTROVIEJO CIRCLE 8,0 CM STRAIGHT	1
KP 001/13	GREEN STRABISMUS HOOK 13,0 CM	1
KP 010/14	GASS RETINAL DETACHMENT HOOK 14,0 CM	1
KP 015/01	GRAEFE STRABISMUS HOOK #1 13,0 CM	1
KP 015/02	GRAEFE STRABISMUS HOOK #2 14,0 CM	1
KP 015/03	GRAEFE STRABISMUS HOOK #3 15,0 CM	1
KP 018/12	STEVENS TENOTOMY HOOK 12,0 CM	1
KP 175/09	CASTROVIEJO EYE SPECULA 16,0 MM 9,0 CM	1
KP 262/13	ARRUGA PROTECTOR 13,0 CM	1
KP 540/13	GONNIN AMSLER MARKER 11-23 MM / 1 MM	1
KP 700/00	BISHOP-HARMON ANTERIOR CHAMBER	1
SK 105/05	WIRE BASKET, 255 X 245 X 50 MM	1

Sterilization Container KYE 200/11, if required

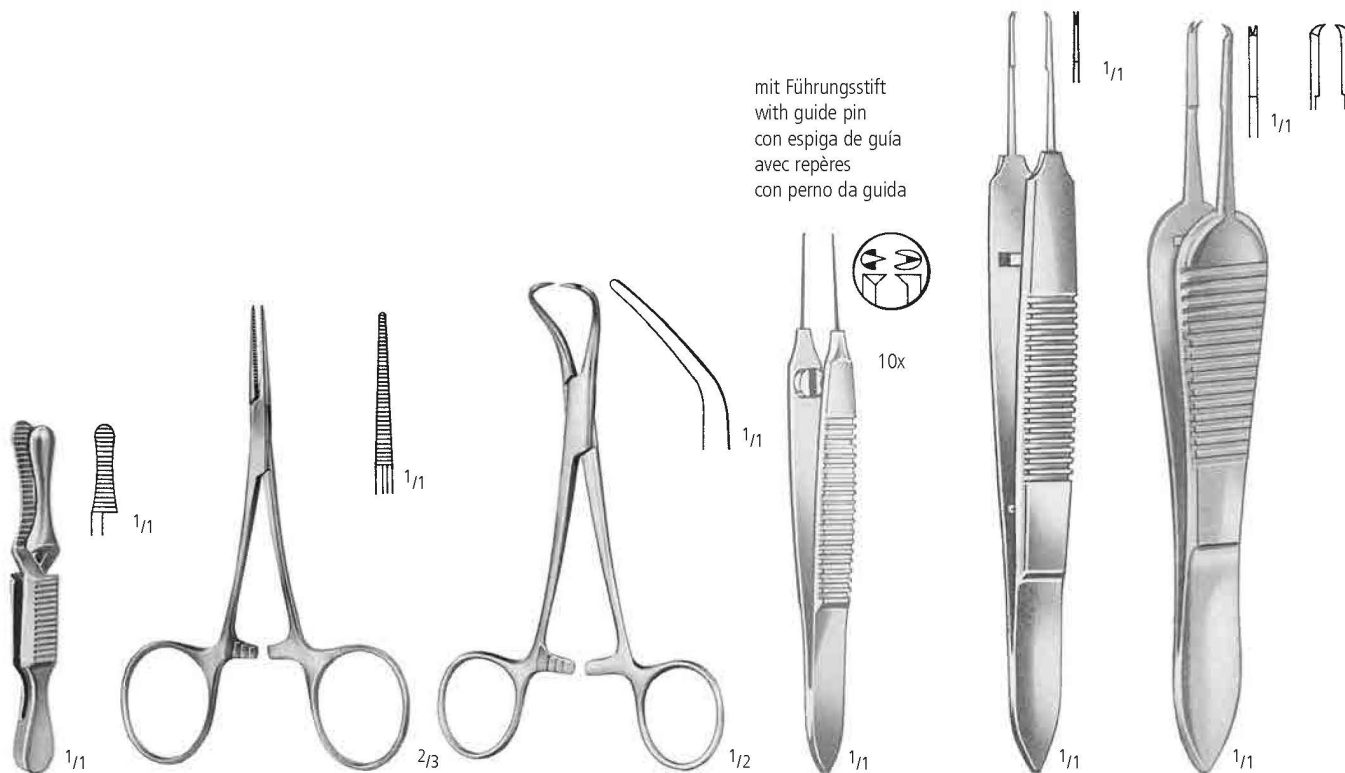

mit Führungsstift  
with guide pin  
con espiga de guía  
avec repères  
con perno da guida

**DIEFFENBACH**

AA 060/03  
3,5 cm/1 1/2"

**HARTMANN**

AA 114/10  
10,0 cm/4"

**BACKHAUS**

AA 751/13  
13,0 cm/5"

**MOD. BONN 1:2**

AB 734/01  
7,0 cm/2 3/4"

**CASTROVIEJO 1:2**

AB 816/01  
0,12 mm  
10,0 cm/4"

**PAUFIQUE 1:2**

AB 828/10  
10,0 cm/4"

Irisscheren  
Iris Scissors  
Tijeras para iridectomía  
Ciseaux à iridectomie  
Forbici per iridectomia

Sehnenscheren  
Tenotomy Scissors  
Tijeras para tenotomía  
Ciseaux à ténatomie  
Forbici per tenotomia

spitz  
pointed  
agudas  
pointues  
acuta

gebogen  
curved  
curvas  
courbes  
curve

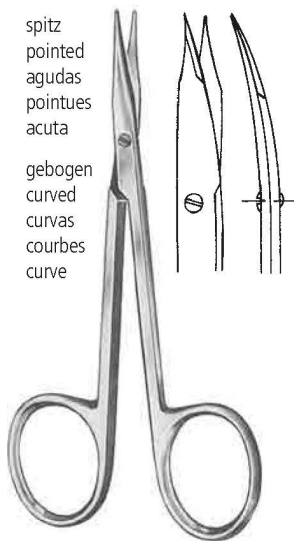
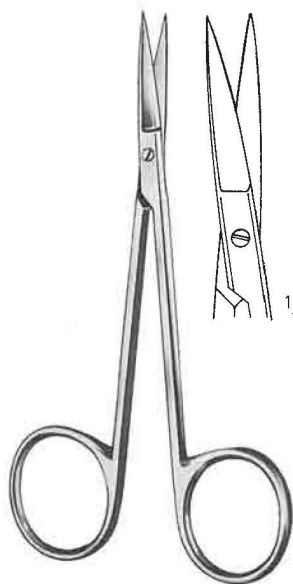

**BERENS**

AB 835/09  
8,5 cm/3 1/3"

**AC 450/10**

10,5 cm/4 1/4"

**STEVENS**

AC 475/11  
11,5 cm/4 1/2"

**WESTCOTT**

AC 780/11  
11,0 cm/4 1/3"

**WESTCOTT**

AC 797/01  
11,5 cm/4 1/2"

**CASTROVIEJO**

14,0 cm/5 1/2"



Messbereich 20 mm  
measuring range 20 mm  
campo de medición 20 mm  
étendue de mesurage 20 mm  
ampiezza di misura 20 mm



**CASTROVIEJO**  
AR 282/20  
8,0 cm / 3"



**GREEN**  
KP 001/13  
13,0 cm / 5"

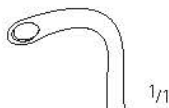

**GASS**  
KP 010/14  
14,0 cm / 5 1/2"

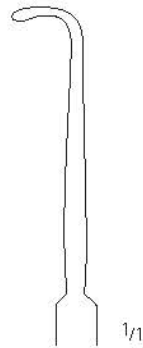

**GRAEFE**  
KP 015/01  
13,0 cm / 5"  
Fig. 1

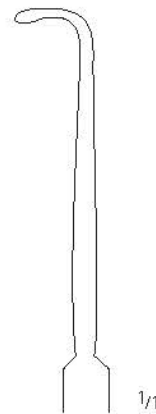

**GRAEFE**  
KP 015/02  
14,0 cm / 5 1/2"  
Fig. 2

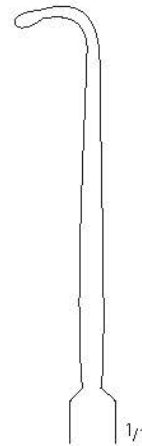

**GRAEFE**  
KP 015/03  
15,0 cm / 6"  
Fig. 3



**STEVENS**  
KP 018/12  
12,0 cm / 4 3/4"



**CASTROVIEJO**  
KP 175/09  
9,0 cm / 3 1/2"  
B = 16 mm



1/1

**ARRUGA**  
 KP 262/13  
 13,0 cm/5"



1/1

**GONNIN**  
 KP 540/13  
 13,0 cm/5"  
 11-23 mm / 1 mm

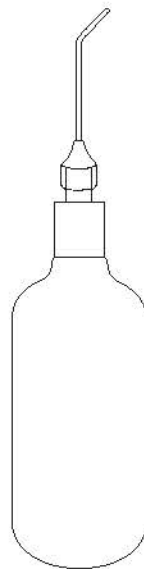

1/2

**BISHOP-HARMON**  
 KP 700/00

Set komplett  
 Set complete  
 Juego completo  
 Jeu complet  
 Set completo



L(mm)	B(mm)	H(mm)	
255	245	50	SK 105/05

**ZS 160/20** CHALAZION CHALAZION CHALAZIÓN CHALAZION CALAZIO

Contents:		Qty
<b>AB 828/10</b>	PAUFIQUE SUTURE FORCEPS 1X2 TEETH 10,0 CM	1
<b>AB 840/01</b>	DESMARRES CHALAZION FORCEPS FIG.1 9,0 CM	1
<b>AB 840/02</b>	DESMARRES CHALAZION FORCEPS FIG.2 9,0 CM	1
<b>AC 467/10</b>	IRIS SCISSORS CVD W LARGE BOWS 10,0 CM	1
<b>AE 661/14</b>	CASTROVIEJO NH CVD RA SMOOTH 14,0 CM	1
<b>KP 248/11</b>	JAEGER LID PLATE 11,0 CM	1
<b>KP 415/10</b>	MEYHOEFER CHALAZION CURETTE 13,0 CM	1
<b>KP 415/20</b>	MEYHOEFER CHALAZIONCURETTE 13,0 CM 2,0 MM	1
<b>KP 415/25</b>	MEYHOEFER CHALAZIONCURETTE 13,0 CM 2,5 MM	1
<b>SK 105/05</b>	WIRE BASKET, 255 X 245 X 50 MM	1

Sterilization Container KYE 200/11, if required



**MOD. TÜBINGEN**  
AB 826/10  
10,0 cm/4"



**DESMARRES**  
9,0 cm/3 1/2"

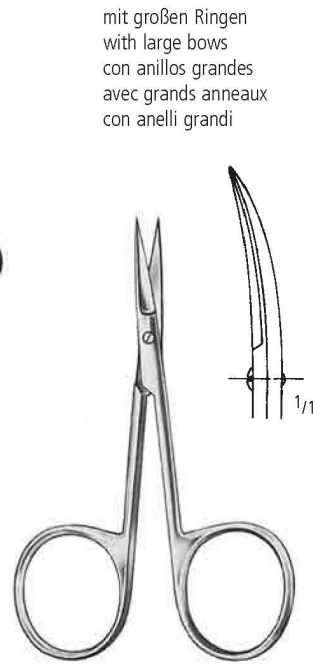

AC 467/10  
10,0 cm/4"



**CASTROVIEJO**  
AE 661/14  
14,0 cm/5 1/2"



**JAEGER**  
KP 248/11  
11,0 cm/4 1/2"



**MEYHOEFER**  
13,0 cm/5"

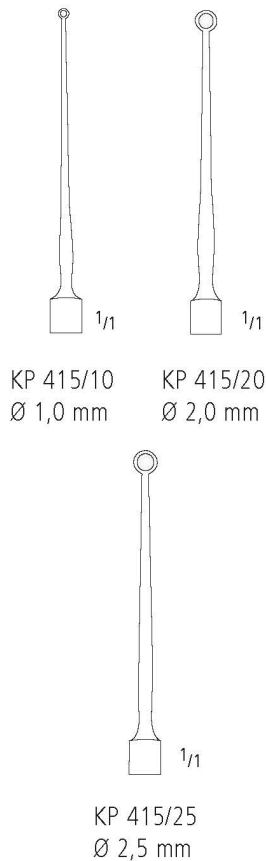

L(mm)	B(mm)	H(mm)	
255	245	50	SK 105/05

**ZS 160/25** ENUKLEATION ENUCLEATION ENUCLEACIÓN ÉNUCLÉATION ENUCLEAZIONE

Contents:		Qty
<b>AA 150/14</b>	HALSTED-MOSQUITO ART.FCPS STR 14,0 CM	2
<b>AA 151/14</b>	HALSTED-MOSQUITO ART.FCPS CVD 14,0 CM	2
<b>AA 751/08</b>	BACKHAUS TOWEL FORCEPS 8,0 CM	2
<b>AB 785/01</b>	GRAEFE FIX.FCPS W/O SPRING CATCH 11,0 CM	1
<b>AB 828/10</b>	PAUFIQUE SUTURE FORCEPS 1X2 TEETH 10,0 CM	1
<b>AB 832/01</b>	BLASCOVICS MUSCULAR FORCEPS FIG.1 9,0 CM	1
<b>AC 461/11</b>	STRABISMUS SCISSORS CVD BLUNT 11,5 CM	1
<b>AC 467/10</b>	IRIS SCISSORS CVD W LARGE BOWS 10,0 CM	1
<b>AC 475/11</b>	STEVENS TENOTOM.SCS.CVD POINTED 11,5 CM	1
<b>AE 661/14</b>	CASTROVIEJO NH CVD RA SMOOTH 14,0 CM	1
<b>KP 015/03</b>	GRAEFE STRABISMUS HOOK FIG. 3 15,0 CM	1
<b>KP 200/15</b>	COOK EYE SPECULA 15 MM 5,0 CM	1
<b>KP 400/01</b>	BUNGE EXENTERATION SPOON 14,0 CM 7,0 MM	1
<b>KP 405/15</b>	WELLS ENUCLEATION SPOON LARGE 15,0 CM	1
<b>SK 105/05</b>	WIRE BASKET, 255 X 245 X 50 MM	1

Sterilization Container KYE 200/11, if required

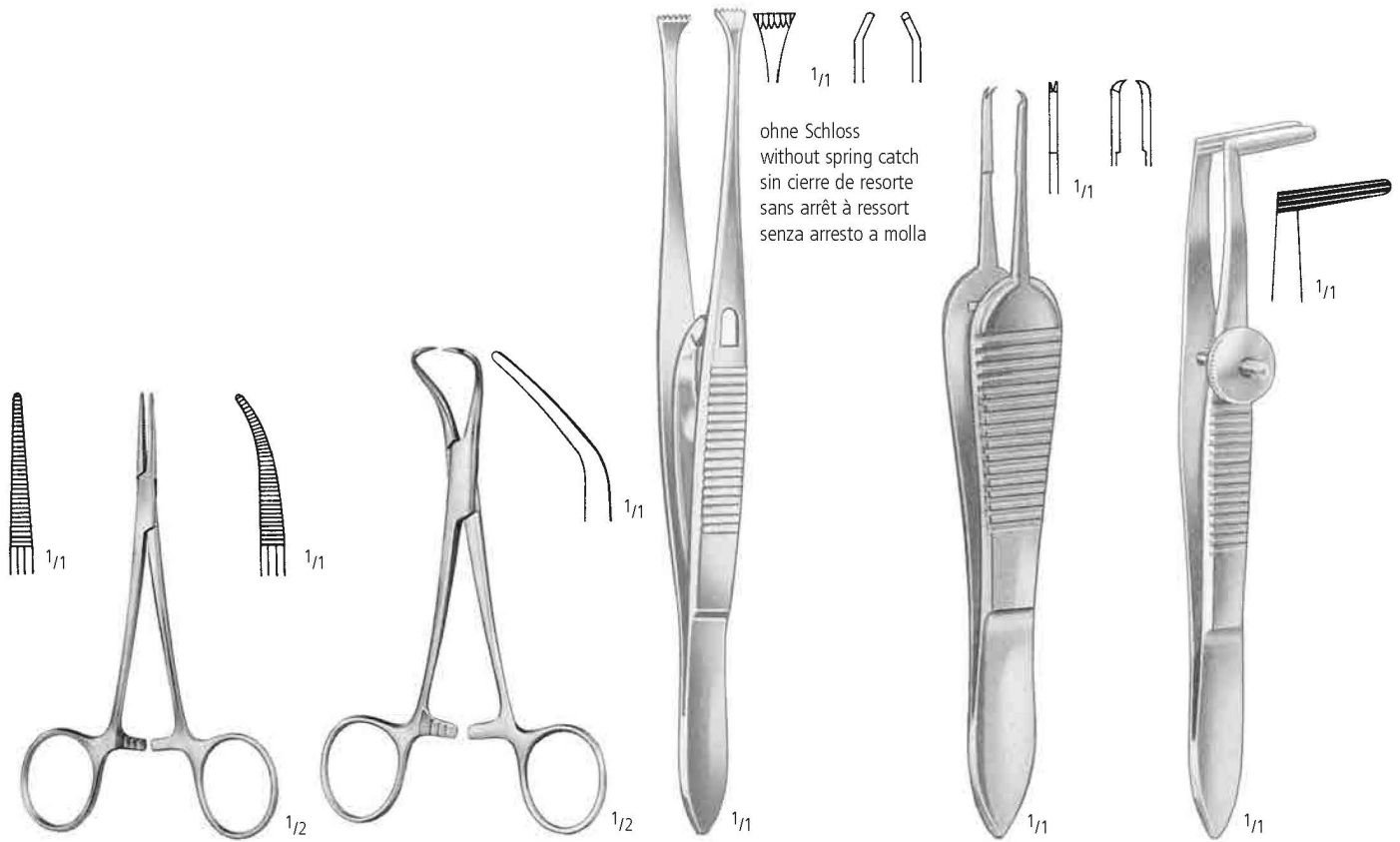

ohne Schloss  
without spring catch  
sin cierre de resorte  
sans arrêt à ressort  
senza arresto a molla

**HALSTED-MOSQUITO**  
AA 150/14 AA 151/14  
14,0 cm/5 1/2"

**BACKHAUS**  
AA 751/08  
8,0 cm/3"

**GRAEFE**  
AB 785/01  
11,0 cm/4 1/3"

**PAUFIGUE 1:2**  
AB 828/10  
10,0 cm/4"

**BLASCOVICS**  
AB 832/01  
9,0 cm/3 1/2"

Strabismusscheren  
Strabismus Scissors  
Tijeras para estrabismos  
Ciseaux à strabisme  
Forbici per strabismo

mit großen Ringen  
with large bows  
con anillos grandes  
avec grands anneaux  
con anelli grandi

Sehnscheren  
Tenotomy Scissors  
Tijeras para tenotomía  
Ciseaux à ténatomie  
Forbici per tenotomia

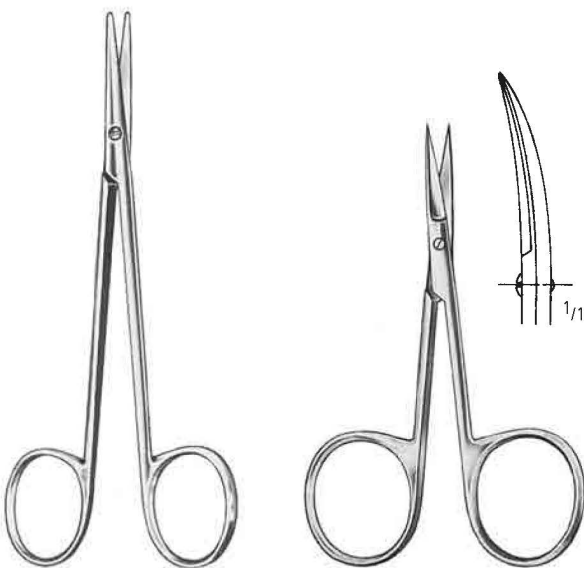

spitz  
pointed  
agudas  
pointues  
acuta

gebogen  
curved  
curvas  
courbes  
curve



AC 460/11  
11,5 cm/4 1/2"

AC 467/10  
10,0 cm/4"

**STEVENS**  
AC 475/11  
11,5 cm/4 1/2"

**CASTROVIEJO**  
AE 661/14  
14,0 cm/5 1/2"



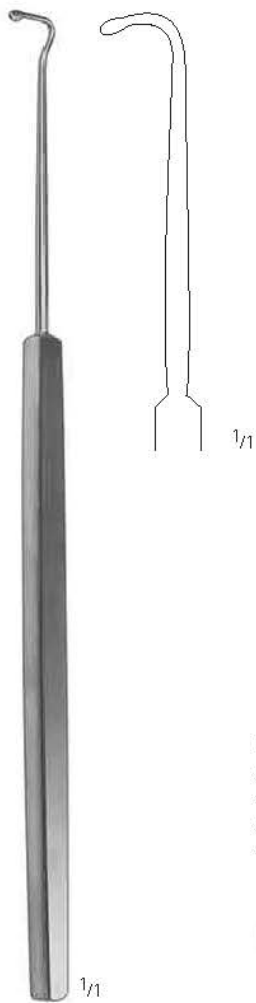

**GRAEFE**  
 KP 015/03  
 15,0 cm/6"  
 Fig. 3



**COOK**  
**B**  
 15 mm  
 KP 200/15  
 5,0 cm/ 2"



**BUNGE**  
 KP 400/01  
 14,0 cm/5 1/2"

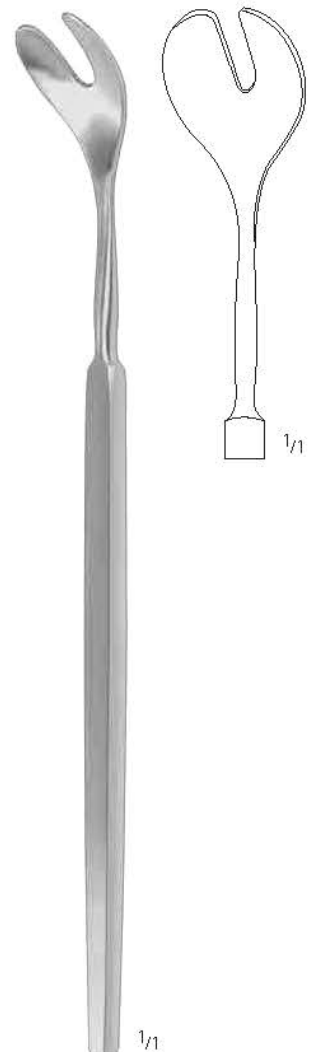

**WELLS**  
 KP 405/15  
 15,0 cm/6"



L(mm)	B(mm)	H(mm)	
255	245	50	SK 105/05





Contents:		Qty
AA 114/10	HARTMANN FORCEPS STR 10,0 CM	1
AA 751/08	BACKHAUS TOWEL FORCEPS 8,0 CM	2
AB 710/10	GRAEFE IRIS FORCEPS STR SERR. 10,0 CM	1
AB 714/10	GRAEFE IRIS FORCEPS STR 1X2 TEETH 10,0 CM	1
AB 734/01	BONN IRIS FORCEPS W.GUIDE PIN 1X2T. 7,0 CM	1
AB 750/07	BARRAQUER-KATZIN FIX.FCPS 1X2 T. 7,0 CM	1
AB 792/11	ELSCHNIG FIXATION FORCPES 1X2 TEETH 11,0 CM	1
AB 825/02	BONN SUTURE FORCEPS 10,0 CM ULRTA FINE	2
AC 431/08	MOD.BONN SCISSORS CVD 8,0 CM	1
AC 768/05	BARRAQUER EYE SCISSORS 5,50 CM 5,0 MM	1
AC 776/02	VANNAS MOD.TÜBINGEN CURVED 8,5 CM	1
AC 782/11	WESTCOTT TENOTOMY SCISSORS BLUNT 11,0 CM	1
AE 605/11	BARRAQUER MICRO-NEEDLE HOLDER CVD 10,0 CM	1
AE 660/14	CASTROVIEJO NH STR RA SMOOTH 14,0 CM	1
AR 282/20	CASTROVIEJO CIRCLE 8,0 CM STRAIGHT	1
KP 130/01	HARMS TRABECULAR PROBE RIGHT 4,5 CM	1
KP 130/02	HARMS TRABECULAR PROBE LEFT 4,5 CM	1
KP 161/05	CORCELLE EYE SPECULA 8 MM, 5,0 CM	1
KP 373/01	PREMIUM DIAMOND KNIFE ANGLED SPEER 1,4 CM	1
KP 376/01	PREMIUM DIAMOND KNIFE 1,0 CM 45° 7 STEPS	1
KP 478/12	MOD.DORTMUND PHACO SPATULA 12,0 CM	1
KP 543/01	SCHIOETZ TONOMETER INCLINED SCALE	1
KP 611/00	ELLIOT TREPHINE HANDLE ONLY 3,0 CM	1
KP 612/10	ELLIOT SCLERAL TREPHINE Ø 1,0 MM	1
KP 700/00	BISHOP-HARMON ANTERIOR CHAMBER	1
KP 712/27	MCINTYRE ANTERIOR CHAMBER CANNULA 27G	2
KP 731/27	SAUTTER AIR INJECTION CANNULA 27G 3,5 CM	2
SK 305/05	WIRE BASKET, 485 X 255 X 50 MM	1

Sterilization Container KYE 200/61, if required

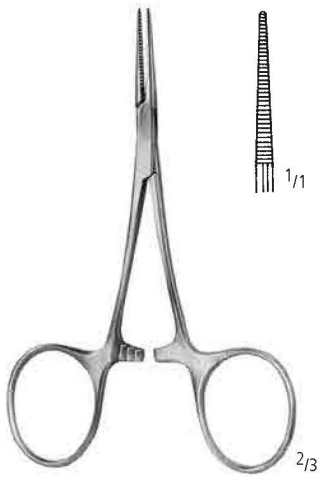

**HARTMANN**  
AA 114/10  
10,0 cm/4"

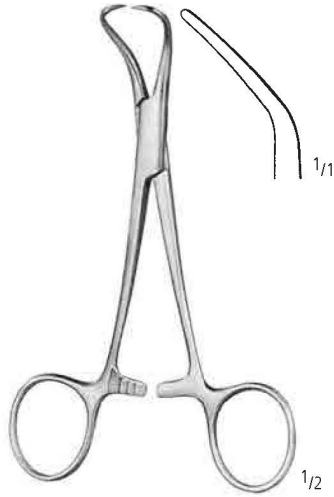

**BACKHAUS**  
AA 751/08  
8,0 cm/3"



**GRAEFE**  
10,0 cm/4"



AB 710/10

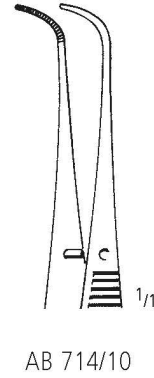

AB 714/10



**MOD. BONN**  
**1:2**  
AB 734/01  
7,0 cm/2<sup>3</sup>/<sub>4</sub>"



10x

mit Führungsstift  
with guide pin  
con espiga de guía  
avec repères  
con perno da guida

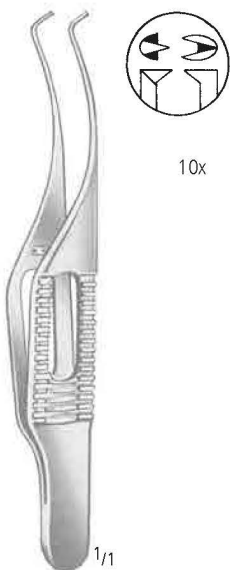

**BARRAQUER-KATZIN 1:2**  
**(Colibri)**  
AB 750/07  
7,0 cm/2<sup>3</sup>/<sub>4</sub>"



**ELSCHNIG 1:2**  
AB 792/11  
11,0 cm/4<sup>1</sup>/<sub>3</sub>"



**MOD. BONN**  
AB 825/02  
10,0 cm/4"



10 x  
0,12 mm

sehr fein  
extra delicate  
muy finas  
très fin  
molto sottile

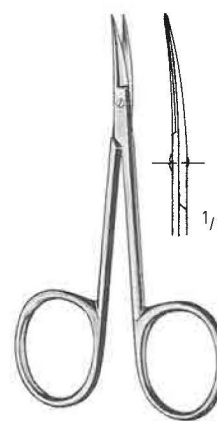

**MOD. BONN**  
AC 431/08  
8,0 cm/3"



**BARRAQUER**  
5 mm AC 768/05  
5,5 cm/2<sup>1</sup>/<sub>4</sub>"



gebogen  
curved  
curvas  
courbes  
curve

1/1

**VANNAS MOD. TÜBINGEN**

AC 776/02  
8,5 cm/3 1/3"



1/1

1/1

**WESTCOTT**

AC 782/11  
11,0 cm/4 1/3"



1/1

1/2

**BARRAQUER**

AE 605/13  
13,0 cm/5"



1/1

2/3

**CASTROVIEJO**

AE 660/14  
14,0 cm/5 1/2"

Messbereich 15 mm  
measuring range 15 mm  
campo de medición 15 mm  
étendue de mesurage 15 mm  
ampiezza di misura 15 mm



1/1

**CASTROVIEJO**

AR 282/15  
8,0 cm/ 3"

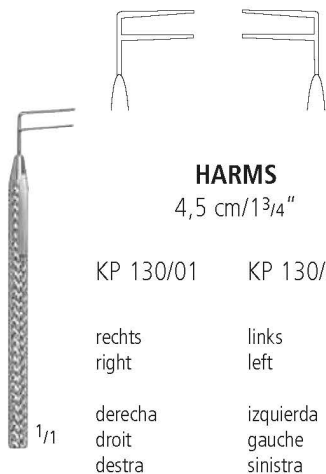

**HARMS**

4,5 cm/1 3/4"

KP 130/01

KP 130/02

rechts  
right

links  
left

derecha  
droit  
destra

izquierda  
gauche  
sinistra

1/1

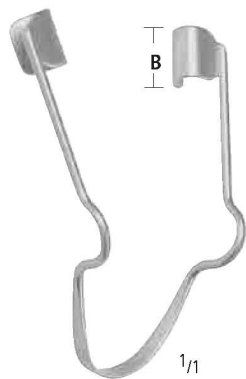

B

1/1

**CORCELLE**

KP 161/05  
5,0 cm/ 2"  
B = 8 mm

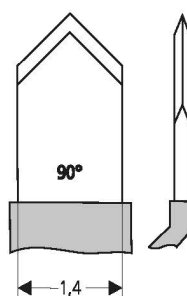

90°

KP 373/01



1/1

7 Stufen:  
7 steps:  
7 escalones:  
7 étages:  
7 gradi:  
0 / 0,3 / 0,4 / 0,5 / 0,6 / 0,8 / 1,0 / 2,5 mm

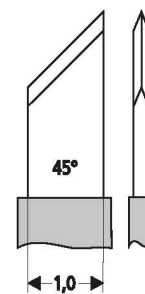

45°

KP 376/01



1/1



**MOD. DORTMUND**

KP 478/12  
12,0 cm / 4<sup>3</sup>/<sub>4</sub>"  
0,6 x 12 mm



schräge Skala  
inclined scale  
graduado inclinado  
échelle oblique  
scala inclinata

**SCHIOETZ**  
KP 543/01  
13,0 cm/5"

Spezifikation Nr. 5, geeicht  
Specification No. 5, calibrated  
Especificación No. 5, calibrada  
Spécification No. 5, calibrée  
Specifica No. 5, calibrata



**ELLIOT**  
KP 611/00  
3,0 cm/1<sup>1</sup>/<sub>4</sub>"



**ELLIOT**  
KP 612/10  
Ø 1,0 mm

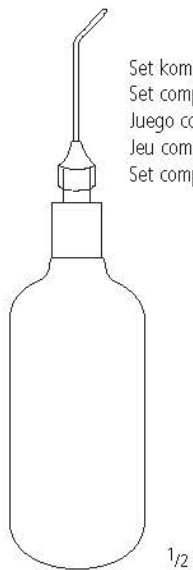

Set komplett  
Set complete  
Juego completo  
Jeu complet  
Set completo

**BISHOP-HARMON**  
KP 700/00



**McINTYRE**  
2,5 cm/1"  
KP 712/27  
27G

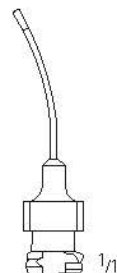

**SAUTTER**  
KP 731/27  
3,5 cm/1<sup>1</sup>/<sub>2</sub>"  
27G

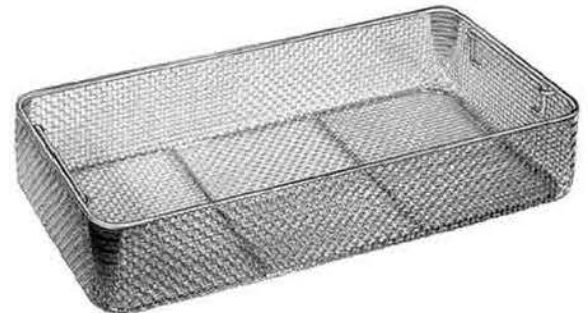

L(mm)	B(mm)	H(mm)	
485	255	50	SK 305/05



Contents:		Qty
AA 060/05	DIEFFENBACH BULLDOG CLAMPS STR 5,0 CM	2
AA 114/10	HARTMANN FORCEPS STR 10,0 CM	1
AA 751/08	BACKHAUS TOWEL FORCEPS 8,0 CM	2
AB 714/10	GRAEFE IRIS FORCEPS STR 1X2 TEETH 10,0 CM	1
AB 735/02	BONN MICRO IRIS FORCEPS ANGLED 7,0 CM	1
AB 750/07	BARRAQUER-KATZIN FIX.FCPS 1X2 T. 7,0 CM	1
AB 768/01	ARRUGA CAPSULAR FCPS NOT CALIBR. 10,0 CM	1
AB 792/11	ELSCHNIG FIXATION FORCPES 1X2 TEETH 11,0 CM	1
AB 819/02	MCPHERSON TYING FORCEPS ANGLED 10,5 CM	1
AB 825/02	BONN SUTURE FORCEPS 10,0 CM ULRTA FINE	1
AB 848/11	FAULKNER LENS HOLDING FORCEPS 11,0 CM	1
AC 431/08	MOD.BONN SCISSORS CVD 8,0 CM	1
AC 768/10	BARRAQUER EYE SCISSORS 5,5 CM 10 MM	1
AC 776/03	VANNAS MOD.TÜBINGEN ANGLED 8,5 CM	1
AC 778/02	VANNAS SEC.CATARACT SCISSORS,CVD. 8,0 CM	1
AC 782/11	WESTCOTT TENOTOMY SCISSORS BLUNT 11,0 CM	1
AC 785/01	CASTROVIEJO DELICATE EYE SCS. 10,0 CM RI.	1
AC 785/02	CASTROVIEJO DELICATE EYE SCS. 10,0 CM LE.	1
AC 797/02	WESTCOTT STRABISMUS SCS CVD SHARP 11,5 CM	1
AD 075/11	PCK=100 BLADES FIG.11	1
AD 554/13	BLADE BREAKER 13.0 CM DIA 8,0 MM	1
AE 603/10	BARRAQUER-TROUTMAN MICRO-NH CVD 10,0 CM	1
AE 660/14	CASTROVIEJO NH STR RA SMOOTH 14,0 CM	1
AE 688/14	KALT MICRO-NEEDLE HOLDER STR 14,0 CM	1
AR 282/20	CASTROVIEJO CIRCLE 8,0 CM STRAIGHT	1
KP 030/13	HIRSCHMANN IRIS HOOK 12,5 CM 45°	1
KP 071/25	SINSKEY LENS MANIPULATOR 12,0 CM	1
KP 154/04	BARRAQUER PHACO EYE SPECULA 4,0 CM	1
KP 440/13	SNELLEN LENS SCOOP SERRATED 13,0 CM	1
KP 478/12	MOD.DORTMUND PHACO SPATULA 12,0 CM	1
KP 545/02	MALONEY KERATOMETER INTRAOPERATIVE 2,0 CM	1
KP 700/00	BISHOP-HARMON ANTERIOR CHAMBER	1
KP 712/27	MCINTYRE ANTERIOR CHAMBER CANNULA 27G	1
KP 720/23	SIMCOE IRRIGATION AND ASPIRATION CANNULA	1
KP 731/27	SAUTTER AIR INJECTION CANNULA 27G 3,5 C	2
KP 755/23	KNOLLE-PEARCE LENS LOOP WITH IRRIGATION	1
KP 767/27	JENSEN CAPSULE POLISHER 27G DIAMOND	1
SK 305/05	WIRE BASKET, 485 X 255 X 50 MM	1

Sterilization Container KYE 200/61, if required

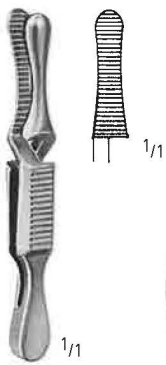

**DIEFFENBACH**  
AA 060/05  
5,0 cm/2"

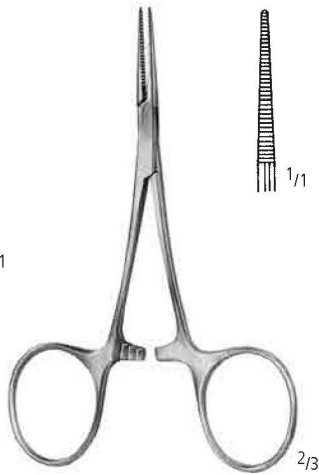

**HARTMANN**  
AA 114/10  
10,0 cm/4"

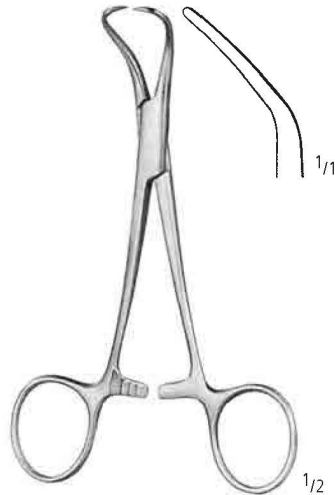

**BACKHAUS**  
AA 751/08  
8,0 cm/3"

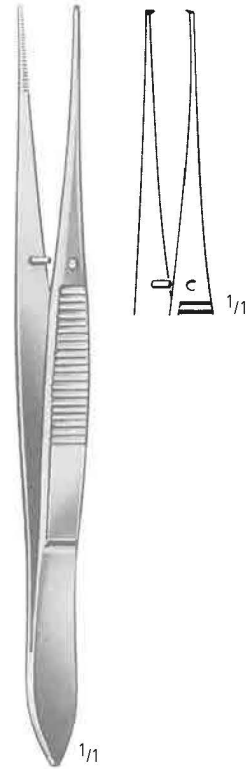

**GRAEFTE**  
AB 714/10  
10,0 cm/4"



**MOD. BONN**  
AB 735/02  
7,0 cm/2<sup>3</sup>/<sub>4</sub>"

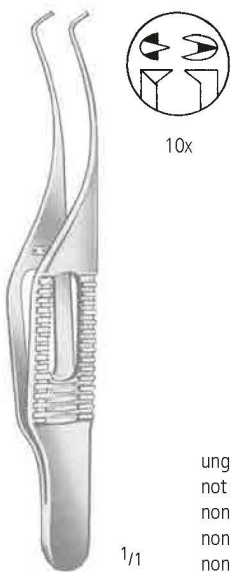

**BARRAQUER-KATZIN 1:2 (Colibri)**  
AB 750/07  
7,0 cm/2<sup>3</sup>/<sub>4</sub>"



ungeeicht  
not calibrated  
non calibrada  
non calibrée  
non calibrata

**ARRUGA**  
AB 768/01  
10,0 cm/4"



**ELSCHNIG 1:2**  
AB 792/11  
11,0 cm/4<sup>1</sup>/<sub>3</sub>"



**McPHERSON**  
AB 819/02  
10,0 cm/4"



**MOD. BONN**  
AB 825/02  
10,0 cm/4"



**FAULKNER**  
AB 848/11  
11,0 cm/4<sup>1</sup>/<sub>3</sub>"

sehr fein  
extra delicate  
muy finas  
très fin  
molto sottile

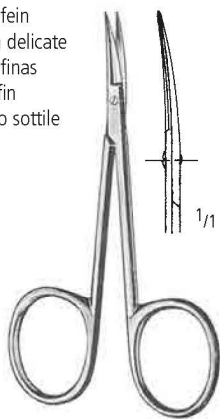

**MOD. BONN**  
AC 431/08  
8,0 cm/3"



**BARRAQUER**  
5,5 cm/2 1/4"  
10 mm AC 768/10

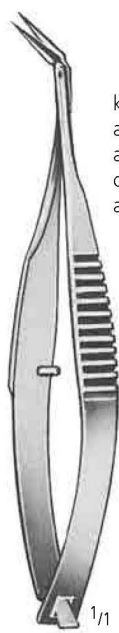

kniegebogen  
angular  
acodadas  
coudés  
angolato

**VANNAS MOD. TÜBINGEN**  
AC 776/03  
8,5 cm/3 1/3"

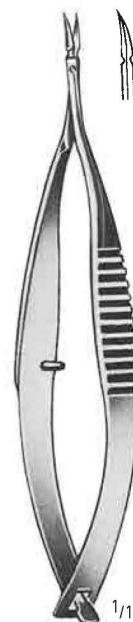

gebogen  
curved  
curvas  
courbes  
curve

**VANNAS**  
AC 778/02  
8,0 cm/3"



**WESTCOTT**  
AC 782/11  
11,0 cm/4 1/3"

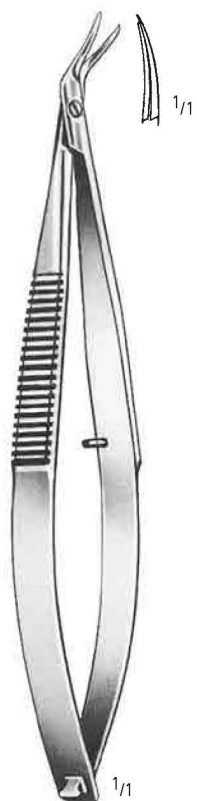

**CASTROVIEJO**  
AC 785/01  
10,0 cm/4"

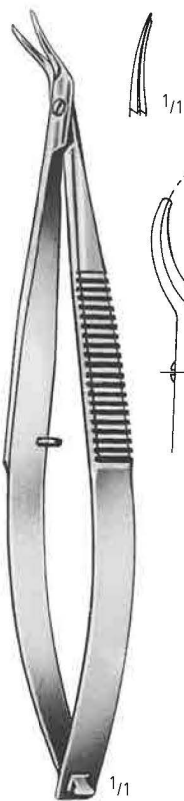

**CASTROVIEJO**  
AC 785/02  
10,0 cm/4"



**WESTCOTT**  
AC 797/02  
11,5 cm/4 1/2"



Fig.11  
AD 075/11

steril  
sterile  
estériles  
stériles  
sterili



**CASTROVIEJO**  
AD 554/13  
Ø 8 mm  
13,0 cm/5"

Messbereich 20 mm  
 measuring range 20 mm  
 campo de medición 20 mm  
 étendue de mesurage 20 mm  
 ampiezza di misura 20 mm

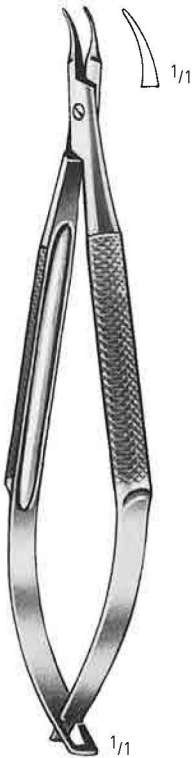

**BARRAQUER-  
 TROUTMAN**  
 AE 603/10  
 10,0 cm/4"

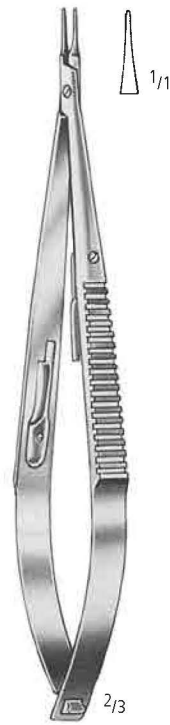

**CASTROVIEJO**  
 AE 660/14  
 14,0 cm/5 1/2"

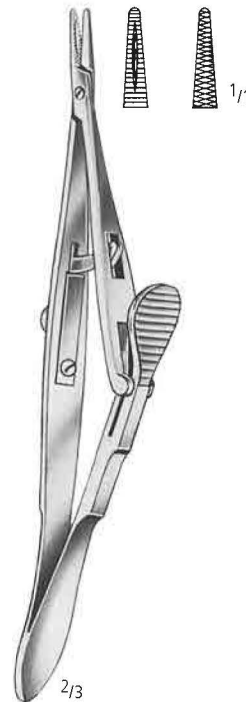

**KALT**  
 AE 688/14  
 14,0 cm/5 1/2"



**CASTROVIEJO**  
 AR 282/20  
 8,0 cm/ 3"

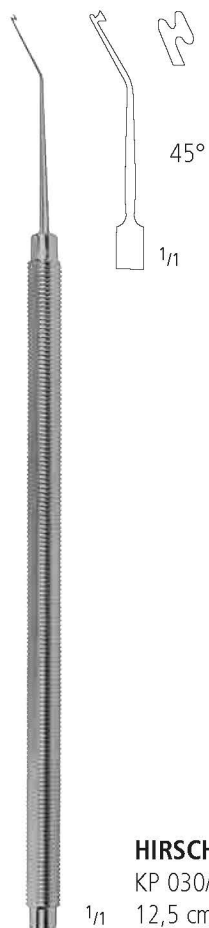

**HIRSCHMANN**  
 KP 030/13  
 12,5 cm/5"



**SINSKEY**  
 KP 071/25  
 Ø 0,25 mm  
 12,0 cm/4 3/4"

**TITANIUM**



**BARRAQUER PHAKO**  
 KP 154/04  
 4,0 cm/1 1/2"

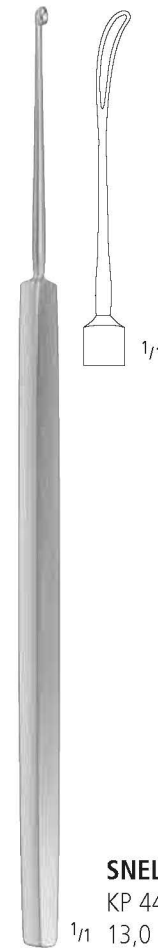

**SNELLEN**  
 KP 440/13  
 13,0 cm/5"

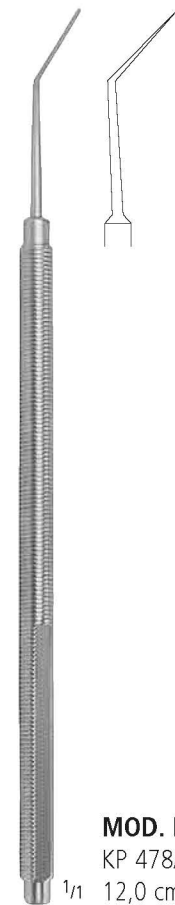

**MOD. DORTMUND**  
 KP 478/12  
 12,0 cm/ 4 3/4"  
 0,6 x 12 mm





**MALONEY**  
KP 545/02  
2,0 cm/3/4"

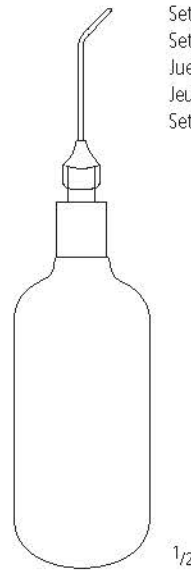

Set komplett  
Set complete  
Juego completo  
Jeu complet  
Set completo

**BISHOP-HARMON**  
KP 700/00

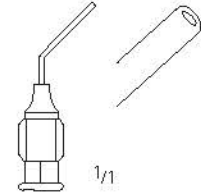

**McINTYRE**  
2,5 cm/1"  
KP 712/27  
27G

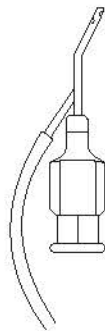

**SIMCOE**  
KP 720/23  
3,0 cm/1 1/4"  
25/23G

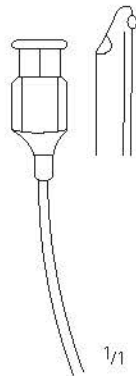

**SAUTTER**  
KP 731/27  
3,5 cm/1 1/2"  
27G

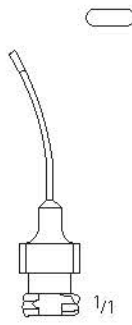

**KNOLLE-PEARCE**  
KP 755/23  
5,0 cm/2"  
23G

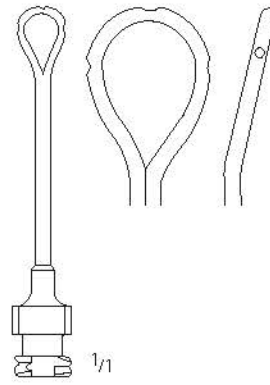

**JENSEN**  
KP 767/27  
4,5 cm/2"  
27G

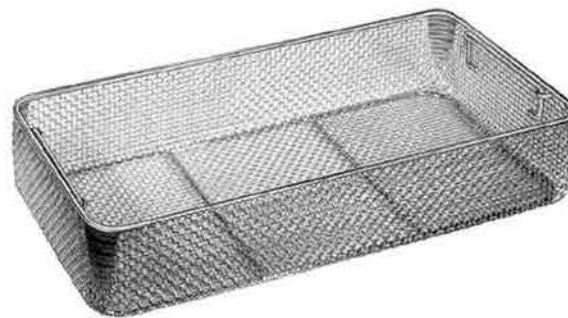

L(mm)	B(mm)	H(mm)	
485	255	50	SK 305/05

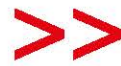

Contents:		Qty
AA 060/05	DIEFFENBACH BULLDOG CLAMPS STR 5,0 CM	2
AA 150/14	HALSTED-MOSQUITO ART.FCPS STR 14,0 CM	1
AA 751/15	BACKHAUS TOWEL FORCEPS 15,0 CM	2
AB 714/10	GRAEFE IRIS FORCEPS STR 1X2 TEETH 10,0 CM	1
AB 750/07	BARRAQUER-KATZIN FIX.FCPS 1X2 T. 7,0 CM	1
AB 767/02	CASTROVIEJO CAPSULAR FCPS CROSSED 10,0 CM	1
AB 768/01	ARRUGA CAPSULAR FCPS NOT CALIBR. 10,0 CM	1
AB 792/11	ELSCHNIG FIXATION FORCPES 1X2 TEETH 11,0 CM	1
AB 819/02	MCPHERSON TYING FORCEPS ANGLED 10,5 CM	1
AB 825/02	BONN SUTURE FORCEPS 10,0 CM ULRTA FINE	1
AB 848/11	FAULKNER LENS HOLDING FORCEPS 11,0 CM	2
AB 852/02	MCDONALD IOL CAPSULORHEXIS FORCEPS 10,0 CM	1
AC 431/08	MOD.BONN SCISSORS CVD 8,0 CM	1
AC 776/04	VANNAS MOD.TÜBINGEN ANGLED O.FL. 8,5 CM	1
AC 778/03	VANNAS SEC.CATARACT SCISSORS,ANGULAR, 8,0 CM	1
AC 782/11	WESTCOTT TENOTOMY SCISSORS BLUNT 11,0 CM	1
AD 075/11	PCK=100 BLADES FIG.11	1
AD 550/09	BLADE BREAKER 9.0 CM DIA 5,5 MM	1
AD 551/09	BLADE BREAKER CVD 9.0 CM DIA 5,5 MM	1
AE 605/14	BARRAQUER MICRO-NEEDLE HOLDER CVD 14,0 CM	1
AE 660/14	CASTROVIEJO NH STR RA SMOOTH 14,0 CM	1
AE 688/14	KALT MICRO-NEEDLE HOLDER STR 14,0 CM	1
AR 282/20	CASTROVIEJO CIRCLE 8,0 CM STRAIGHT	1
KP 030/13	HIRSCHMANN IRIS HOOK 12,5 CM 45°	1
KP 040/02	JAFFE-BECHERT LENS NUCLEUS ROTATOR 12,0 CM	1
KP 067/60	NAGAHARA PHACO SPLITTER 12,0 CM 60°	1
KP 071/25	SINSKEY LENS MANIPULATOR 12,0 CM	1
KP 154/04	BARRAQUER PHACO EYE SPECULA 4,0 CM	1
KP 210/02	LIEBERMAN EYE SPECULA 15 MM K-SHAPE 8,0 CM	1
KP 335/12	MOD. HAMBURG KERATOME 12,0 CM	1
KP 370/04	PREMIUM DIAMOND KNIFE ANGLED LANCE 1,4 CM	1
KP 371/01	PREMIUM DIAMOND KNIFE STR.TRI-FACET 1,0 CM	1
KP 371/02	PREMIUM DIAMOND KNIFE ANGLED 2,0 CM	1
KP 545/02	MALONEY KERATOMETER INTRAOPERATIVE 2,0 CM	1
KP 550/12	THORNTON FIXATION RING FG-HINGE Ø13,0 MM	1
KP 700/00	BISHOP-HARMON ANTERIOR CHAMBER	1
KP 712/27	MCINTYRE ANTERIOR CHAMBER CANNULA 27G	1
KP 731/27	SAUTTER AIR INJECTION CANNULA 27G 3,5 CM	1
KP 767/27	JENSEN CAPSULE POLISHER 27G DIAMOND	2
SK 305/05	WIRE BASKET, 485 X 255 X 50 MM	1

Sterilization Container KYE 200/61, if required

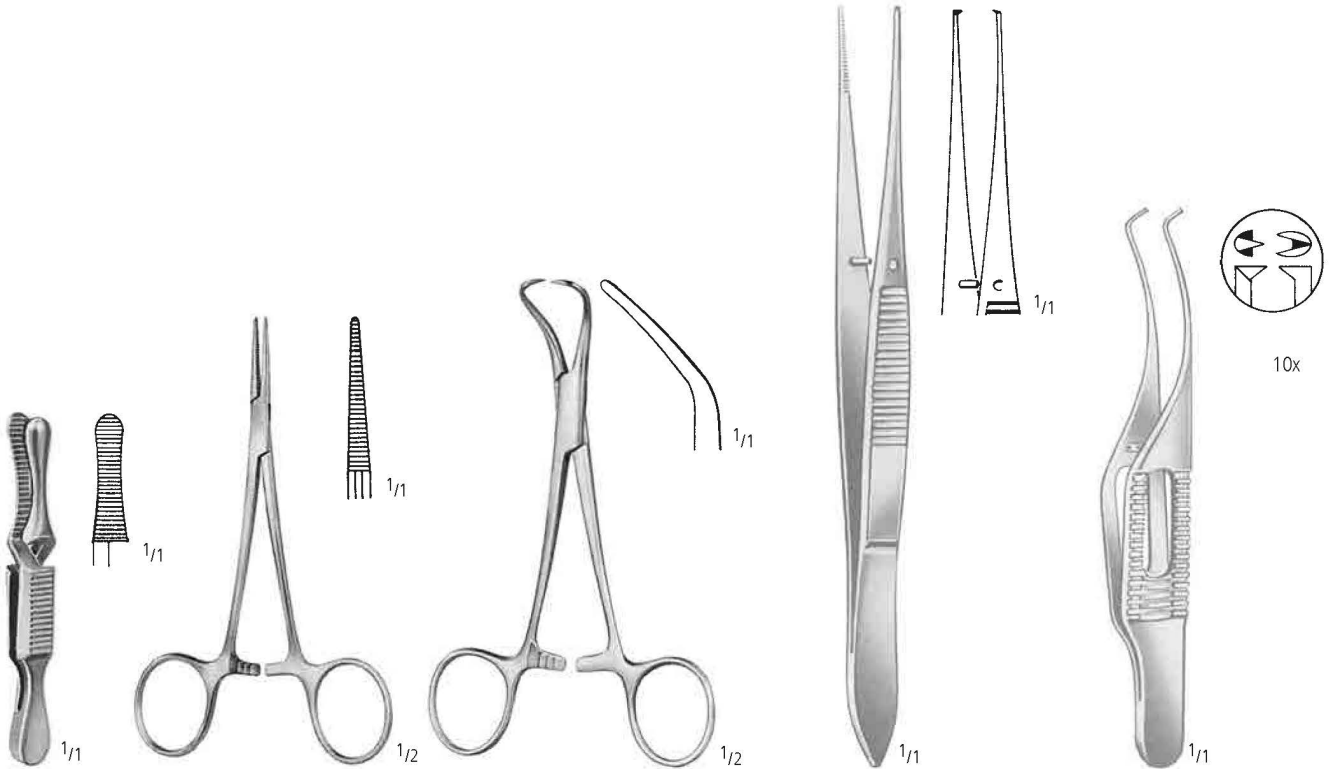

**DIEFFENBACH**

AA 060/05  
 5,0 cm/2"

**HALSTED-MOSQUITO**

AA 150/14  
 14,0 cm/5 1/2"

**BACKHAUS**

AA 751/15  
 15,0 cm/6"

**GRAEFE**

AB 714/10  
 10,0 cm/4"

**BARRAQUER-KATZIN 1:2  
 (Colibri)**

AB 750/07  
 7,0 cm/2 3/4"

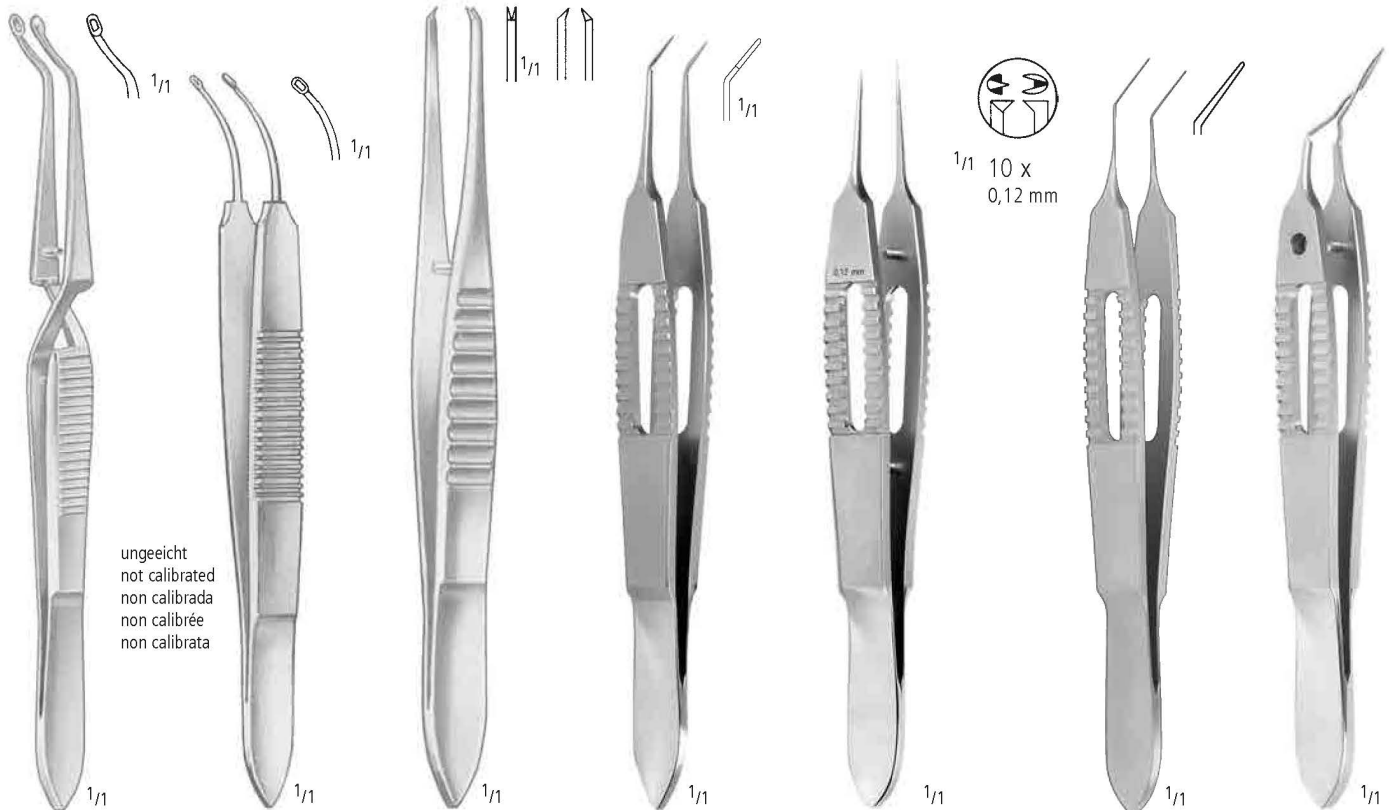

ungeeicht  
 not calibrated  
 non calibrada  
 non calibrée  
 non calibrata

**CASTROVIEJO**

AB 767/02  
 10,0 cm/4"

**ARRUGA**

AB 768/01  
 10,0 cm/4"

**ELSCHMIG 1:2**

AB 792/11  
 11,0 cm/4 1/3"

**McPHERSON**

AB 819/02  
 10,0 cm/4"

**MOD. BONN**

AB 825/02  
 10,0 cm/4"

**FAULKNER**

AB 848/11  
 11,0 cm/4 1/3"

**McDONALD**

AB 852/02  
 10,0 cm/4"

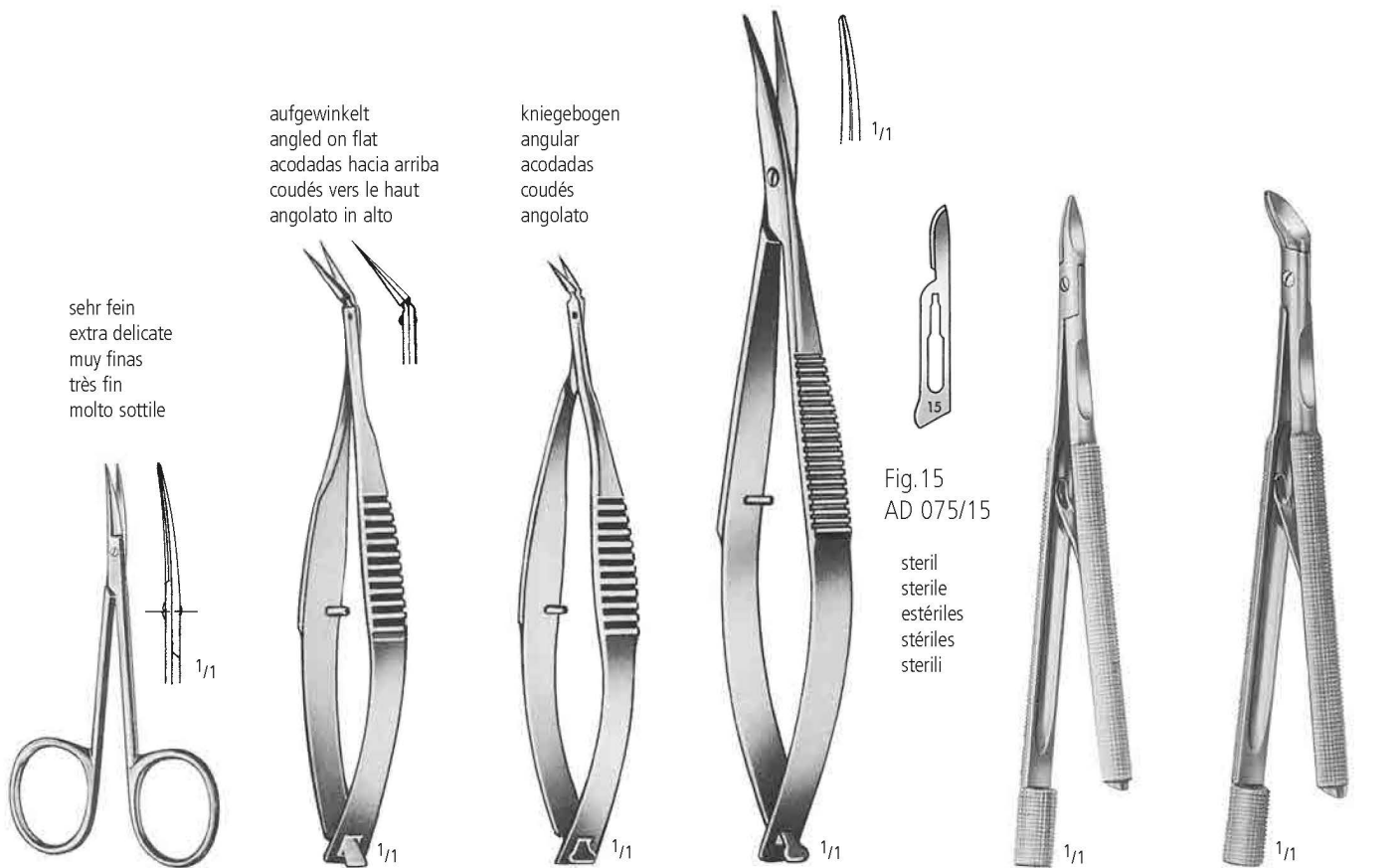

**MOD. BONN**  
 AC 431/08  
 8,0 cm/3"

**VANNAS MOD. TÜBINGEN**  
 AC 776/04  
 8,5 cm/3<sup>1</sup>/<sub>3</sub>"

**VANNAS**  
 AC 778/03  
 8,0 cm/3"

**WESTCOTT**  
 AC 782/11  
 11,0 cm/4<sup>1</sup>/<sub>3</sub>"

**TROUTMAN-CHRIS** **TROUTMAN-CHRIS**  
 AD 550/09 AD 551/09  
 Ø 5,5 mm Ø 5,5 mm  
 9,0 cm/3<sup>1</sup>/<sub>2</sub>" 9,0 cm/3<sup>1</sup>/<sub>2</sub>"

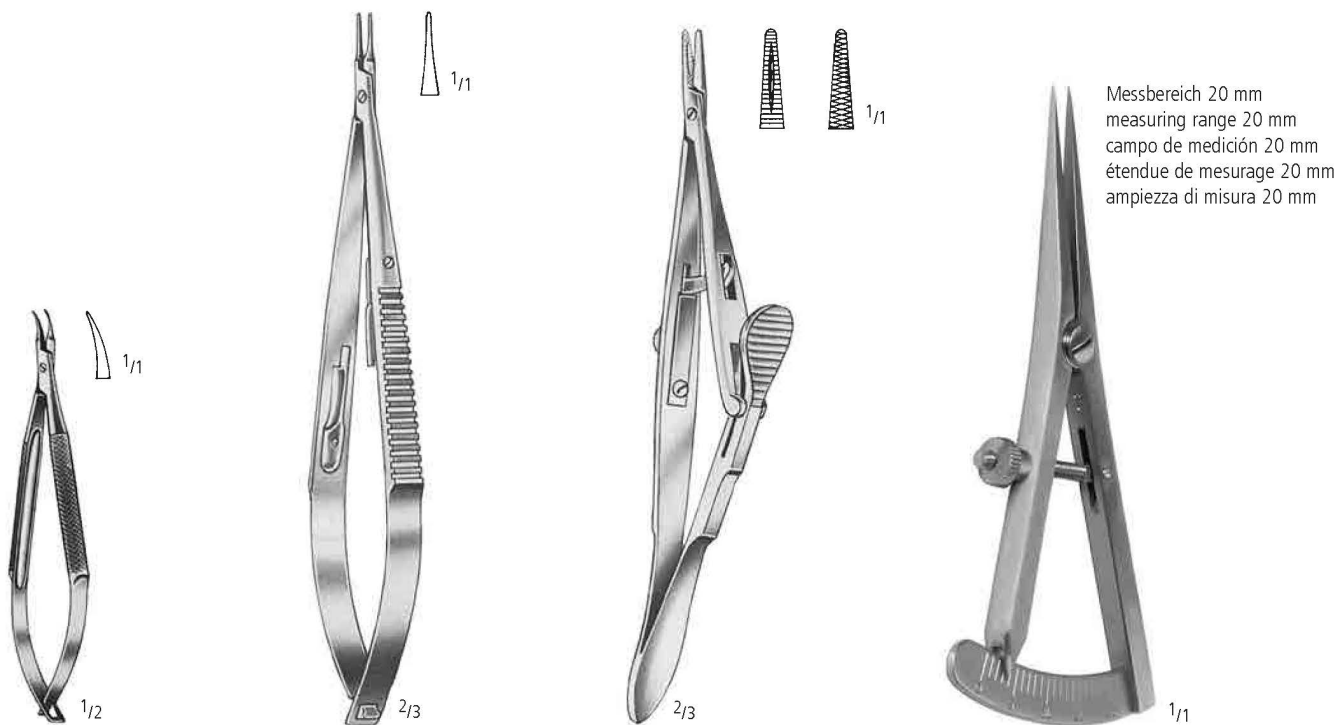

**BARRAQUER**  
 AE 605/11  
 11,0 cm/4<sup>1</sup>/<sub>3</sub>"

**CASTROVIEJO**  
 AE 660/14  
 14,0 cm/5<sup>1</sup>/<sub>2</sub>"

**KALT**  
 AE 688/14  
 14,0 cm/5<sup>1</sup>/<sub>2</sub>"

**CASTROVIEJO**  
 AR 282/20  
 8,0 cm/ 3"



ZS 160/40

KATARAKT LINSE CATARACT PHACOEMULSIFICATION CATARATA FACOEMULSIFICACIÓN  
 CATARACTE PHACOËMULSIFICATION CATARATTA FACOEMULSIFICAZIONE



**HIRSCHMANN**  
 KP 030/13  
 12,5 cm/5"



**JAFFE-BECHERT**  
 KP 040/02  
 12,0 cm/4¾"  
 L = 9 mm



**NAGAHARA**  
 KP 067/60  
 12,0 cm/4¾"  
 60°

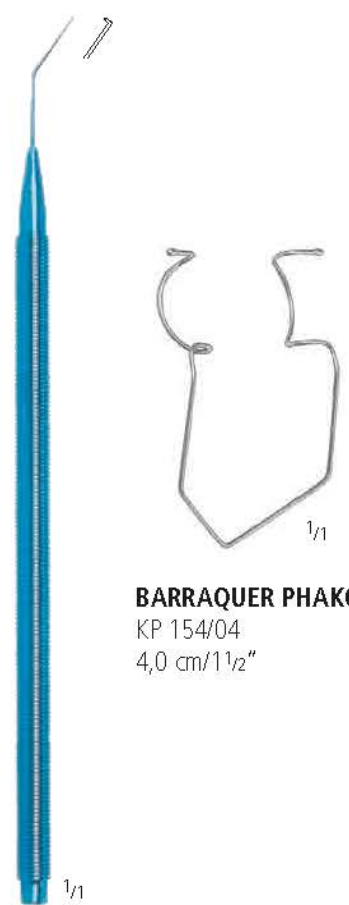

**BARRAQUER PHAKO**  
 KP 154/04  
 4,0 cm/1½"

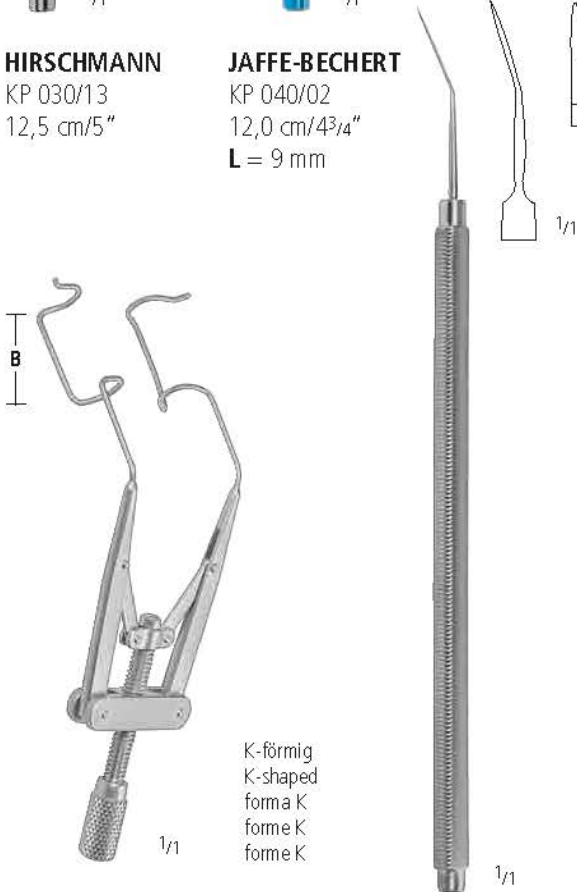

**LIEBERMAN**  
 KP 210/02  
 8,0 cm/3¼"  
 B = 15 mm

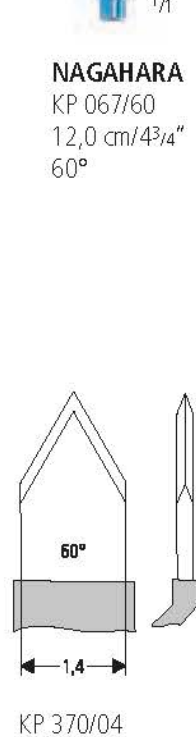

**MOD. HAMBURG**  
 KP 335/12  
 12,0 cm/ 4¾"



**SINSKEY**  
 KP 071/25  
 12,0 cm/4¾"  
 Ø 0,25 mm

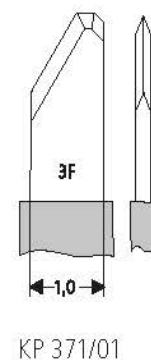

KP 371/01

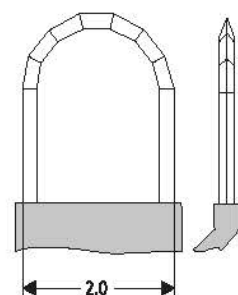

KP 371/02



**MALONEY**  
 KP 545/02  
 2,0 cm/3/4"

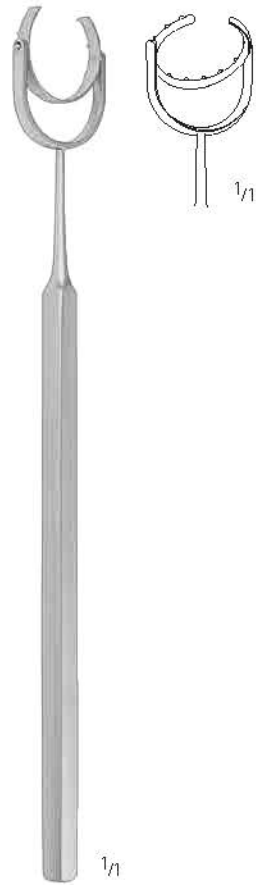

**THORNTON**  
 KP 550/12  
 12,0 cm/4 3/4"  
 Ø 13 mm

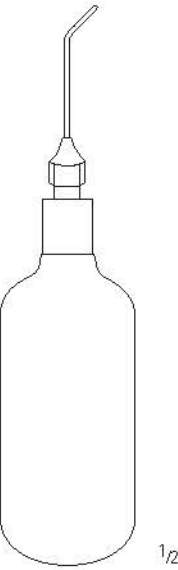

**BISHOP-HARMON**  
 KP 700/00

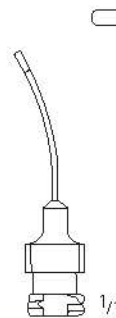

**SAUTTER**  
 KP 731/27  
 3,5 cm/1 1/2"  
 27G

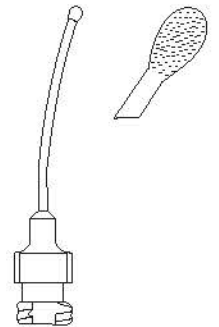

**JENSEN**  
 KP 767/27  
 4,5 cm/2"  
 27G

Set komplett  
 Set complete  
 Juego completo  
 Jeu complet  
 Set completo

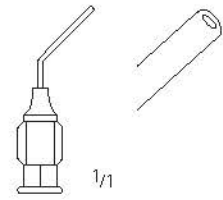

**McINTYRE**  
 2,5 cm/1"  
 KP 712/27  
 27G

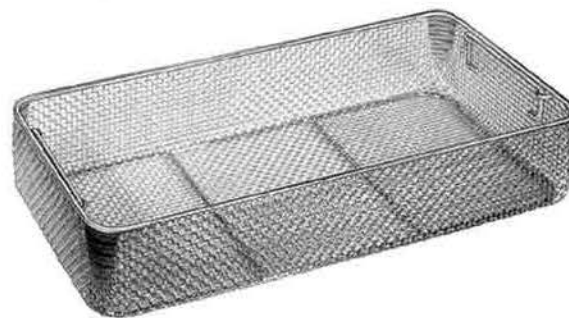

L(mm)	B(mm)	H(mm)	
485	255	50	SK 305/05





Contents:		Qty
AA 150/14	HALSTED-MOSQUITO ART.FCPS STR 14,0 CM	1
AA 751/15	BACKHAUS TOWEL FORCEPS 15,0 CM	2
AB 714/10	GRAEFE IRIS FORCEPS STR 1X2 TEETH 10,0 CM	
1		
AB 750/07	BARRAQUER-KATZIN FIX.FCPS 1X2 T. 7,0 CM	1
AB 792/11	ELSCHNIG FIXATION FORCPES 1X2 TEETH 11,0 CM	1
AB 816/10	CASTROVIEJO SUTURE FORCEPS 1.0MM 10,0 CM	1
AB 825/02	BONN SUTURE FORCEPS 10,0 CM ULRTA FINE	2
AC 431/08	MOD.BONN SCISSORS CVD 8,0 CM	1
AC 778/01	VANNAS SEC.CATARACT SCISSORS,STR. 8,0 CM	1
AC 782/11	WESTCOTT TENOTOMY SCISSORS BLUNT 11,0 CM	1
AC 785/01	CASTROVIEJO DELICATE EYE SCS.10,0 CM RIGHT	1
AC 791/01	KATZIN MICRO SCISSORS LEFT 11,0 CM	1
AC 791/02	KATZIN MICRO SCISSORS RIGHT 11,0 CM	1
AE 605/14	BARRAQUER MICRO-NEEDLE HOLDER CVD 14,0 CM	1
AE 660/14	CASTROVIEJO NH STR RA SMOOTH 14,0 CM	1
AE 688/14	KALT MICRO-NEEDLE HOLDER STR 14,0 CM	1
KP 150/15	BARRAQUER-COLIBRI EYE SPECULA 15 MM 4,0 CM	1
KP 325/05	BONN SCLERA KNIFE 5MM 12,5 CM	1
KP 370/02	PREMIUM DIAMOND KNIFE STR. 1,0 CM 45°	1
KP 508/10	BORES AXIS MARKER 10,0 CM	1
KP 535/12	ANIS SUTURE PLACEMENT MARKER 8 BLADES	1
KP 545/02	MALONEY KERATOMETER INTRAOPERATIVE 2,0 CM	1
KP 603/70	FRANCESCHETTI CERATOPLASTY TREPHINE	1
KP 603/80	FRANCESCHETTI CERATOPLASTY TREPHINE	1
KP 640/14	FLIERINGA SCLERAL FIXATION RING Ø 14,0 MM	1
KP 640/16	FLIERINGA SCLERAL FIXATION RING Ø 16,0 MM	1
KP 640/18	FLIERINGA SCLERAL FIXATION RING Ø 18,0 MM	1
KP 640/20	FLIERINGA SCLERAL FIXATION RING Ø 20,0 MM	1
KP 700/00	BISHOP-HARMON ANTERIOR CHAMBER	1
KP 731/27	SAUTTER AIR INJECTION CANNULA 27G 3,5 CM	2
SK 305/05	WIRE BASKET, 485 X 255 X 50 MM	1

Sterilization Container KYE 200/61, if required



**HALSTED-MOSQUITO**  
AA 150/14  
14,0 cm/5 1/2"

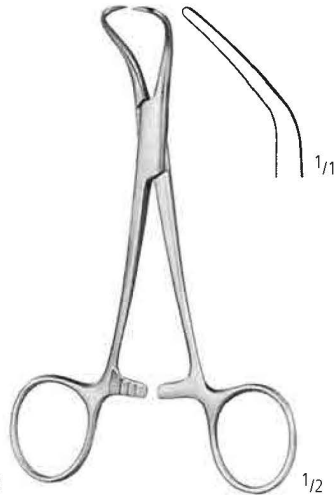

**BACKHAUS**  
AA 751/15  
15,0 cm/6"

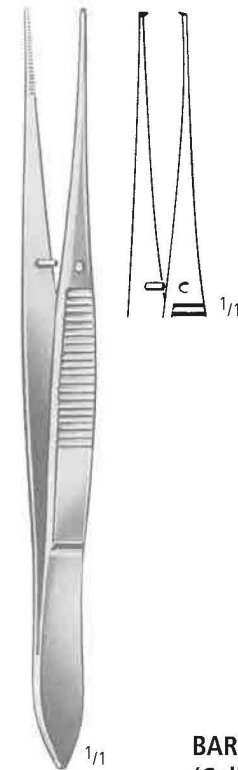

**GRAEFE**  
AB 714/10  
10,0 cm/4"

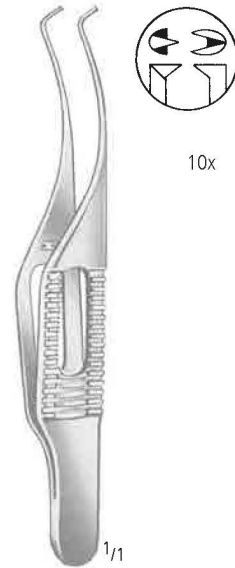

**BARRAQUER-KATZIN 1:2 (Colibri)**  
AB 750/07  
7,0 cm/2 3/4"



**ELSCHNIG 1:2**  
AB 792/11  
11,0 cm/4 1/3"



**CASTROVIEJO 1:2**  
AB 816/10  
1,00 mm  
10,0 cm/4"



**MOD. BONN**  
AB 825/02  
10,0 cm/4"

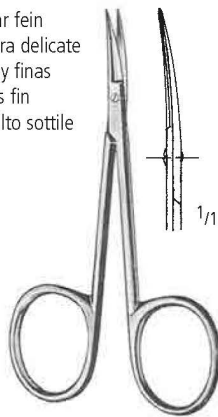

**MOD. BONN**  
AC 431/08  
8,0 cm/3"

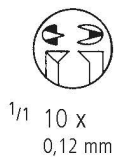

sehr fein  
extra delicate  
muy finas  
très fin  
molto sottile

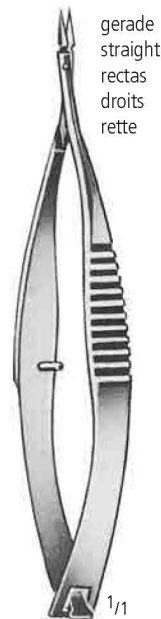

**VANNAS**  
AC 778/01  
8,0 cm/3"



**WESTCOTT**  
AC 782/11  
11,0 cm/4 1/3"



**CASTROVIEJO**  
AC 785/01  
10,0 cm/4"

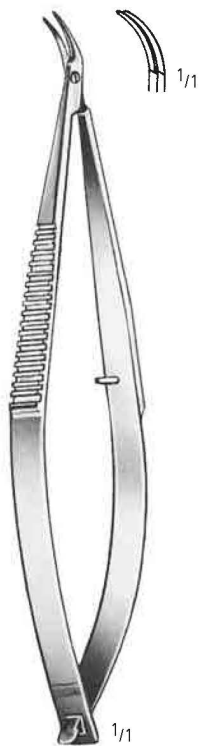

**KATZIN**  
AC 791/01  
11,0 cm/4<sup>1</sup>/<sub>3</sub>"



**KATZIN**  
AC 791/02  
11,0 cm/4<sup>1</sup>/<sub>3</sub>"



**BARRAQUER**  
AE 605/11  
11,0 cm/4<sup>1</sup>/<sub>3</sub>"

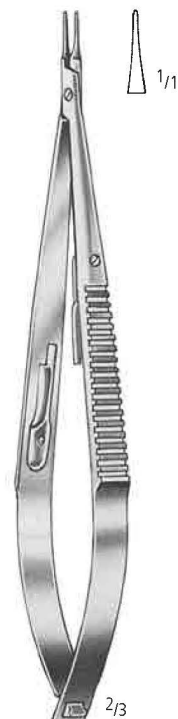

**CASTROVIEJO**  
AE 660/14  
14,0 cm/5<sup>1</sup>/<sub>2</sub>"

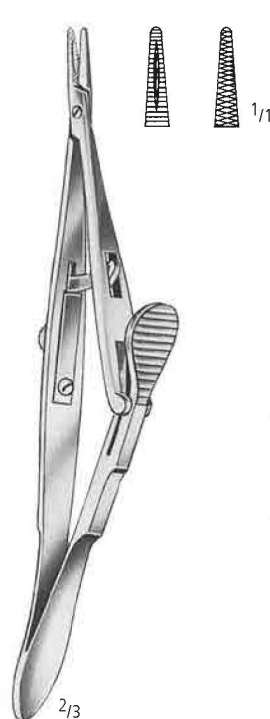

**KALT**  
AE 688/14  
14,0 cm/5<sup>1</sup>/<sub>2</sub>"

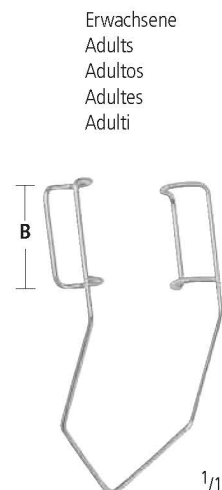

**BARRAQUER-COLIBRI**  
B  
15 mm KP 150/15  
4,0 cm/1<sup>1</sup>/<sub>2</sub>"

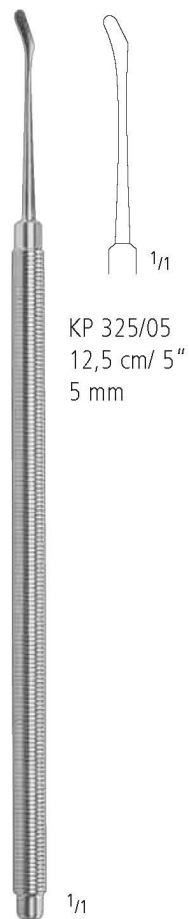

**BONN**

KP 325/05  
12,5 cm/ 5"  
5 mm



KP 370/02

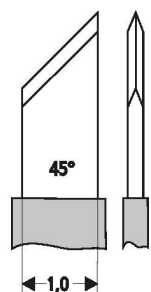

**BORES**  
KP 508/10  
10,0 cm/4"

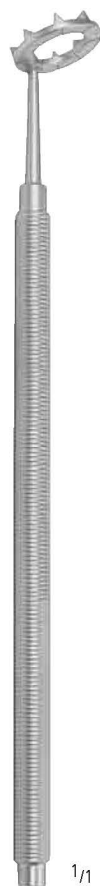
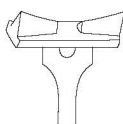

**ANIS**  
KP 535/12  
12,0 cm/4<sup>3</sup>/<sub>4</sub>"



**MALONEY**  
KP 545/02  
2,0 cm/3<sup>1</sup>/<sub>4</sub>"



mm Ø  
7,0 KP 603/70  
8,0 KP 603/80  
**FRANCESCETTI**  
7,5 cm/3"

Set komplett  
Set complete  
Juego completo  
Jeu complet  
Set completo



**FLIERINGA**

mm Ø

14	KP 640/14
16	KP 640/16
18	KP 640/18
20	KP 640/20

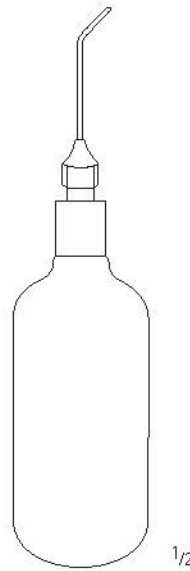

**BISHOP-HARMON**  
KP 700/00

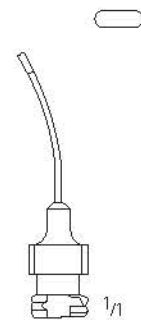

**SAUTTER**  
KP 731/27  
3,5 cm/1 1/2"  
27G

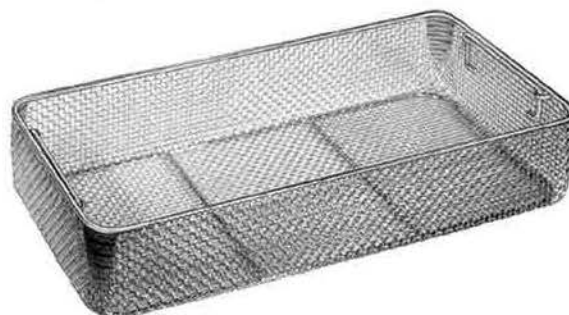

L(mm)	B(mm)	H(mm)	
485	255	50	SK 305/05

Contents:		Qty
<b>AB 750/07</b>	BARRAQUER-KATZIN FIX.FCPS 1X2 T. 7,0 CM	1
<b>KP 154/04</b>	BARRAQUER PHACO EYE SPECULA 4,0 CM	1
<b>KP 375/01</b>	PREMIUM DIAMOND KNIFE 1,0 CM 15°	1
<b>KP 500/70</b>	HOFFER OPTICAL ZONE MARKER 7,0 MM 10,0 CM	1
<b>KP 500/80</b>	HOFFER OPTICAL ZONE MARKER 8,0 MM 10,0 CM	1
<b>KP 508/10</b>	BORES AXIS MARKER 10,0 CM	1
<b>KP 515/12</b>	LINDSTROM CORNEAL OPTICAL ZONE MARKER	1
<b>KP 547/11</b>	MENDEZ MEASURING INSTRUMENT DEGREE 10°C	1
<b>KP 550/12</b>	THORNTON FIXATION RING FG-HINGE Ø 13,0 MM	1
<b>KP 741/23</b>	LACRIMAL CANNULA 23G 4,0 CM CURVED	2
<b>SK 105/05</b>	WIRE BASKET, 255 X 245 X 50 MM	1

Sterilization Container KYE 200/11, if required



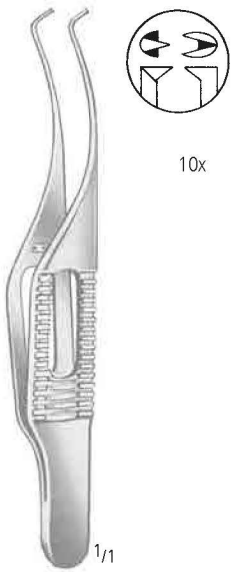

10x



1/1

**BARRAQUER-KATZIN 1:2**

**(Colibri)**

AB 750/07  
7,0 cm/2¾"

**BARRAQUER PHAKO**

KP 154/04  
4,0 cm/1½"

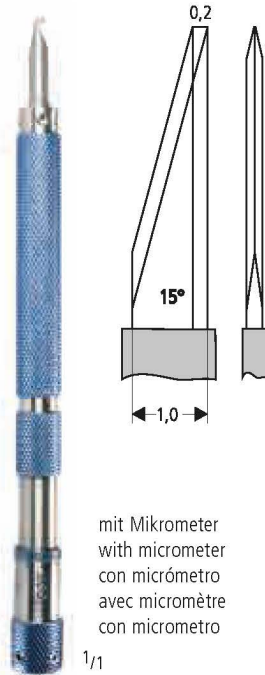

mit Mikrometer  
with micrometer  
con micrómetro  
avec micromètre  
con micrometro

1/1

KP 375/01



1/1

**HOFFER**

10,0 cm/4"  
Ø 7,00 mm  
Ø 8,00 mm

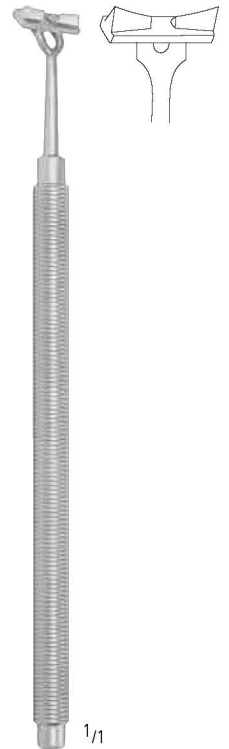

1/1

**BORES**

KP 508/10  
10,0 cm/4"

KP 500/70  
KP 500/80



1/1

**LINDSTROM**

KP 515/12  
12,0 cm/4¾"  
7 mm



1/1

**MENDEZ**

KP 547/11  
11,0 cm/4½"  
C 10°, 0 -180°

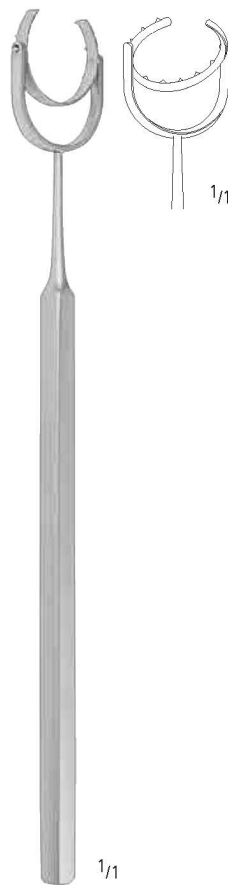

1/1

**THORNTON**

KP 550/12  
12,0 cm/4¾"  
Ø 13 mm

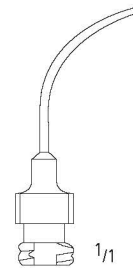

1/1

KP 741/23  
3,5 cm/1½"  
23G



L(mm)	B(mm)	H(mm)	
255	245	50	SK 105/05



Contents:		Qty
AA 060/06	DIEFFENBACH BULLDOG CLAMPS STR 6,0 CM	2
AA 151/12	HALSTED-MOSQUITO FCPS CVD 12,5 CM	1
AA 751/08	BACKHAUS TOWEL FORCEPS 8,0 CM	2
AB 710/07	GRAEFE IRIS FORCEPS STR SERR. 7,0 CM	1
AB 714/07	GRAEFE IRIS FORCEPS STR 1X2 TEETH 700 CM	1
AB 750/07	BARRAQUER-KATZIN FIX.FCPS 1X2 T. 7,0 CM	1
AB 792/11	ELSCHNIG FIXATION FORCPES 1X2 TEETH 11,0 CM	1
AB 816/01	CASTROVIEJO SUTURE FORCEPS 0,12 MM 10,0CM	1
AB 825/02	BONN SUTURE FORCEPS 10,0 CM ULRTA FINE	1
AB 825/02	BONN SUTURE FORCEPS 10,0 CM ULRTA FINE	1
AB 828/10	PAUFIQUE SUTURE FORCEPS 1X2 TEETH 10,0 CM	1
AB 833/01	JAMESON MUSCULAR FORCEPS 10,0 CM RIGHT	1
AB 833/02	JAMESON MUSCULAR FORCEPS 10,0 CM LEFT	1
AC 461/11	STRABISMUS SCISSORS CVD BLUNT 11,5 CM	1
AC 466/10	IRIS SCISSORS STR W LARGE BOWS 10,0 CM	1
AC 768/05	BARRAQUER EYE SCISSORS 5,5 CM 5,0 MM	1
AC 780/11	WESTCOTT TENOTOMY SCS.POINTED 11,0 CM	1
AC 782/11	WESTCOTT TENOTOMY SCISSORS BLUNT 11,0 CM	1
AD 075/11	PCK=100 BLADES FIG. 11	1
AD 550/09	BLADE BREAKER 9.0 CM DIA 5,5 MM	1
AE 605/14	BARRAQUER MICRO-NEEDLE HOLDER CVD 14,0 CM	1
AE 607/14	BARRAQUER MICRO-NH CVD RA 14,0 CM	1
AE 652/09	CASTROVIEJO NH STR RA 9,0 CM	1
AR 250/15	MEASURING INSTRUMENT 15,0 CM	1
AR 282/20	CASTROVIEJO CIRCLE 8,0 CM STRAIGHT	1
KP 001/13	GREEN STRABISMUS HOOK 13,0 CM	1
KP 002/12	JAMESON MUSCLE HOOK 12,0 CM	1
KP 010/14	GASS RETINAL DETACHMENT HOOK 14,0 CM	1
KP 015/01	GRAEFE STRABISMUS HOOK #1 13,0 CM	1
KP 015/02	GRAEFE STRABISMUS HOOK #2 14,0 CM	1
KP 015/03	GRAEFE STRABISMUS HOOK #3 15,0 CM	1
KP 150/15	BARRAQUER-COLIBRI EYE SPECULA 15 MM 4,0 CM	1
KP 261/15	SAUTTER ORBITAL SPATUL MEDIUM 15,0 CM	1
KP 495/13	WECKER IRIS SPATULA 2MM SILVER 13,0 CM	1
KP 542/01	SCHIOETZ TONOMETER STRAIGHT SCALE	1
SK 305/05	WIRE BASKET, 485 X 255 X 50 MM	1

Sterilization Container KYE 200/61, if required

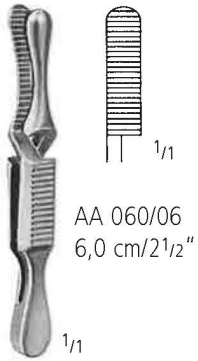

AA 060/06  
 6,0 cm/2 1/2"

**DIEFFENBACH**



**HALSTED-MOSQUITO**

AA 151/12  
 12,5 cm/5"

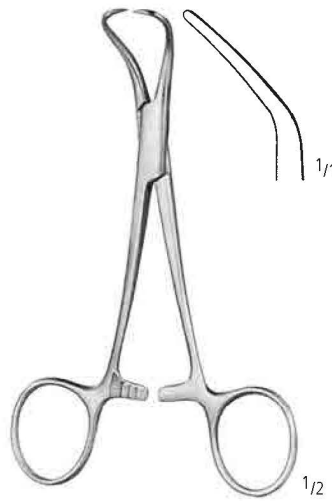

**BACKHAUS**

AA 751/08  
 8,0 cm/3"



**GRAEFE**



AB 710/07  
 7,0 cm/2 3/4"

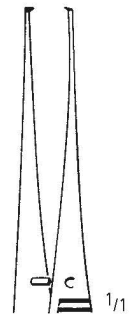

AB 714/07  
 7,0 cm/2 3/4"

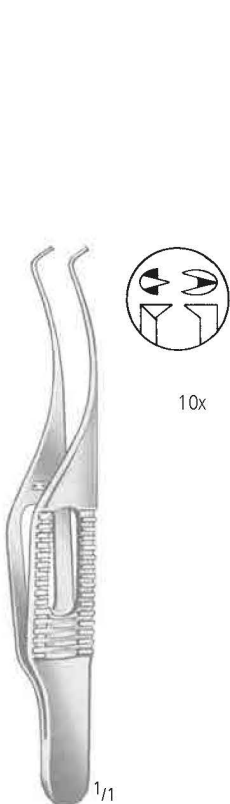

**BARRAQUER-KATZIN 1:2 (Colibri)**  
 AB 750/07  
 7,0 cm/2 3/4"



**ELSCHNIG 1:2**  
 AB 792/11  
 11,0 cm/4 1/3"



**CASTROVIEJO 1:2**  
 AB 816/01 0,12 mm  
 10,0 cm/4"



10 x  
 0,12 mm



**MOD. BONN**  
 AB 825/02  
 10,0 cm/4"



**PAUFIQUE 1:2**  
 AB 828/10  
 10,0 cm/4"

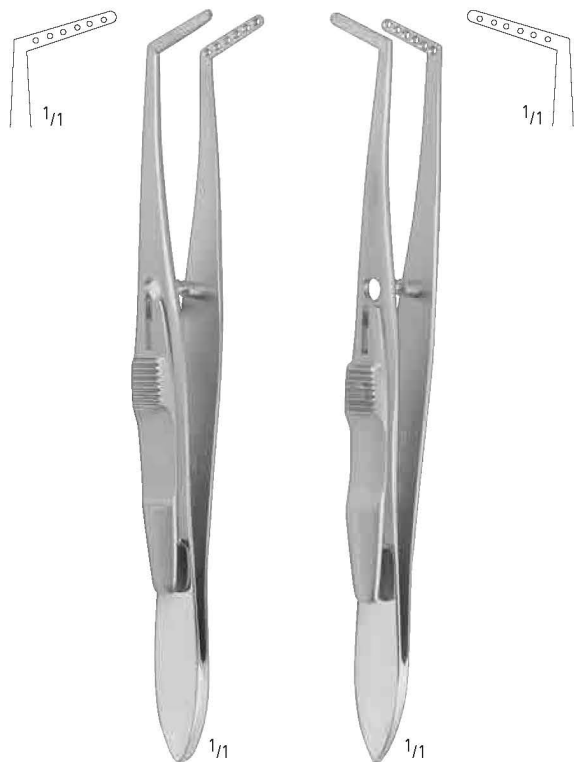

Strabismusscheren  
 Strabismus Scissors  
 Tijeras para estrabismos  
 Ciseaux à strabisme  
 Forbici per strabismo

mit großen Ringen  
 with large bows  
 con anillos grandes  
 avec grands anneaux  
 con anelli grandi

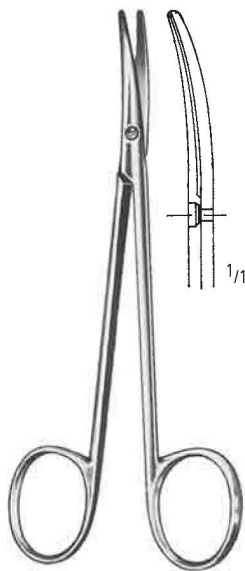

**JAMESON**  
 AB 833/01  
 10,0 cm/4"

**JAMESON**  
 AB 833/02  
 10,0 cm/4"

AC 461/11  
 11,5 cm/4 1/2"

AC 466/10  
 10,0 cm/4"

**BARRAQUER**  
 5,5 cm/2 1/4"  
 AC 768/05  
 5 mm



Fig. 11  
 AD 075/11

steril  
 sterile  
 estériles  
 stériles  
 sterili

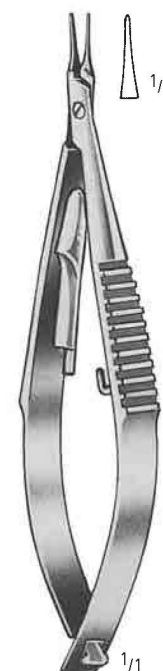
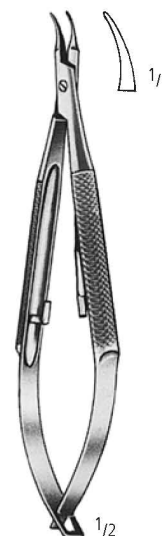
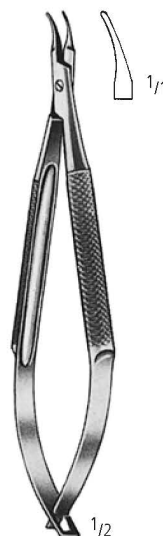

**WESTCOTT**  
 AC 780/11  
 11,0 cm/4 1/3"

**WESTCOTT**  
 AC 782/11  
 11,0 cm/4 1/3"

**TROUTMAN-CHRIS**  
 AD 550/09  
 Ø 5,5 mm  
 9,0 cm/3 1/2"

**BARRAQUER**  
 AE 605/14  
 14,0 cm/5 1/2"

**BARRAQUER**  
 AE 607/14  
 14,0 cm/5 1/2"

**CASTROVIEJO**  
 AE 652/09  
 9,0 cm/3 1/2"



Messbereich 20 mm  
measuring range 20 mm  
campo de medición 20 mm  
étendue de mesurage 20 mm  
ampiezza di misura 20 mm



AR 250/15  
15,0 cm/6"

**CASTROVIEJO**  
AR 282/20  
8,0 cm/ 3"

Erwachsene  
Adults  
Adultos  
Adultes  
Adulti

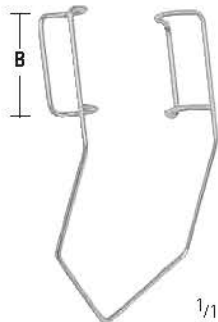

**BARRAQUER-COLIBRI**

**B**  
15 mm  
KP 150/15  
4,0 cm/1 1/2"

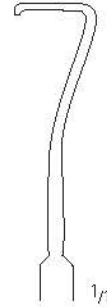

**GREEN**  
KP 001/13  
13,0 cm/5"

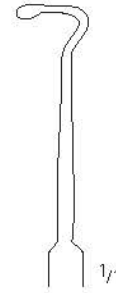

**JAMESON**  
KP 002/12  
12,0 cm/4 3/4"

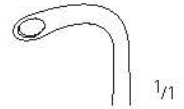

**GASS**  
KP 010/14  
14,0 cm/5 1/2"

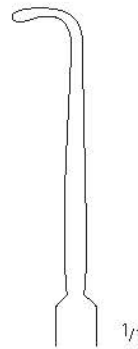

**GRAEFE**  
KP 015/01  
13,0 cm/5"  
Fig. 1

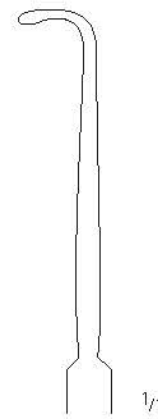

**GRAEFE**  
KP 015/02  
14,0 cm/5 1/2"  
Fig. 2

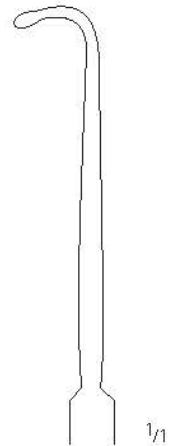

**GRAEFE**  
KP 015/03  
15,0 cm/6"  
Fig. 3



ZS 160/55

NETZHAUTABLÖSUNG RETINAL DETACHMENT DESPRENDIMIENTO DE RETINA  
 DÉCOLLEMENT DE LA RÉTINE DISTACCO DELLA RETINA

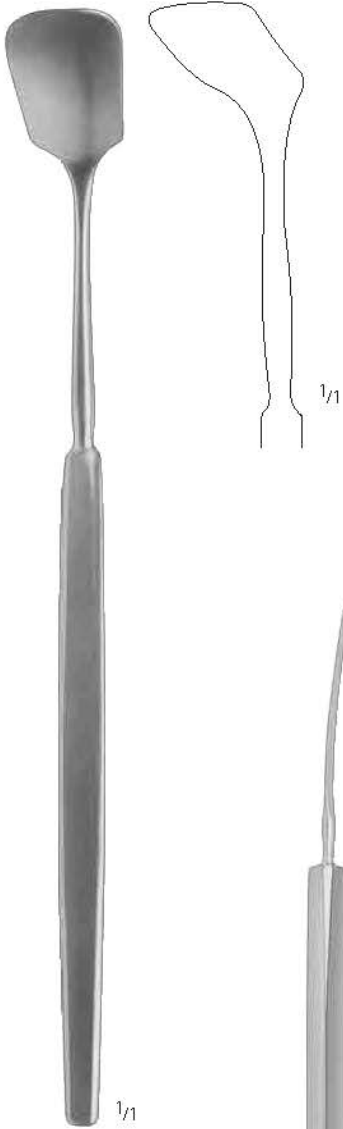

**SAUTTER**  
 KP 261/15  
 15,0 cm/6"



**WECKER**  
 KP 495/13  
 13,0 cm/5"  
 2 mm

biegsam  
 malleable  
 maleable  
 malléable  
 malleabile



gerade Skala  
 straight scale  
 graduado recto  
 échelle droite  
 scala retta

**SCHIOETZ**  
 KP 542/01  
 13,0 cm/5"

Spezifikation Nr. 5, geeicht  
 Specification No. 5, calibrated  
 Especificación No. 5, calibrada  
 Spécification No. 5, calibrée  
 Specifica No. 5, calibrata

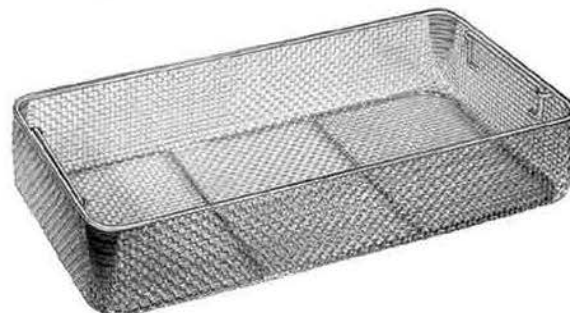

L(mm)	B(mm)	H(mm)	
485	255	50	SK 305/05

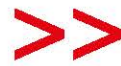



Contents:		Qty
AA 150/14	HALSTED-MOSQUITO ART.FCPS STR 14,0 CM	2
AA 151/14	HALSTED-MOSQUITO ART.FCPS CVD 14,0 CM	2
AA 711/09	JONES TOWEL FORCEPS 9,0 CM	2
AB 628/09	ZIEGLER CILIA FORCEPS 9,0 CM	1
AB 785/01	GRAEFE FIX.FCPS W/O SPRING CATCH 11,0 CM	1
AB 816/01	CASTROVIEJO SUTURE FORCEPS 10,0 CM	2
AB 824/02	BONACCOLTO SUTURE FORCEPS 10,0 CM FINE	1
AB 829/01	HARMS TYING FORCEPS STRAIGHT 10,0 CM	1
AB 840/01	DESMARRES CHALAZION FORCEPS FIG.1 9,0 CM	1
AB 841/01	LAMBERT CHALAZION FORCEPS 9,0 CM ROUND	1
AB 844/20	BERKE PTOSIS FORCEPS 11,0 CM, 20 MM	1
AC 450/10	IRIS SCISSORS STR SH/SH 10,5 CM	1
AC 475/10	STEVENS TENOTOM.SCS POINTED CVD 10,5 CM	1
AC 782/11	WESTCOTT TENOTOMY SCISSORS BLUNT 11,0 CM	1
AC 797/01	WESTCOTT STRABISMUS SCS STR SHARP 11,5 CM	1
AE 663/14	CASTROVIEJO NH CVD RA SERRATED 14,0 CM	1
AE 688/14	KALT MICRO-NEEDLE HOLDER STR 14,0 CM	1
AK 074/01	GUTHRIE DELICATE HOOK FIG.1 16,0 CM	1
AK 078/13	KNAPP DELICATE HOOK BLUNT 13,0 CM	1
AK 090/12	DESMARRES RETRACTOR 12 MM 13,0 CM	1
AK 090/14	DESMARRES RETRACTOR 14 MM 13,0 CM	1
AK 090/16	DESMARRES RETRACTOR 16 MM 13,0 CM	1
AR 282/20	CASTROVIEJO CIRCLE 8,0 CM STRAIGHT	1
KP 015/01	GRAEFE STRABISMUS HOOK #1 13,0 CM	1
KP 015/02	GRAEFE STRABISMUS HOOK #2 14,0 CM	1
KP 248/11	JAEGER LID PLATE 11,0 CM	1
KP 325/05	BONN SCLERA KNIFE 5MM 12,5 CM	1
KP 415/10	MEYHOEFER CHALAZION CURETTE 13,0 CM	1
KP 415/20	MEYHOEFER CHALAZIONCURETTE 13,0 CM 2,0 MM	1
KP 415/25	MEYHOEFER CHALAZIONCURETTE 13,0 CM 2,5 MM	1
KP 415/35	MEYHOEFER CHALAZIONCURETTE 13,0 CM 3,5 MM	1
KP 700/00	BISHOP-HARMON ANTERIOR CHAMBER	1
SK 305/05	WIRE BASKET, 485 X 255 X 50 MM	1

Sterilization Container KYE 200/61, if required

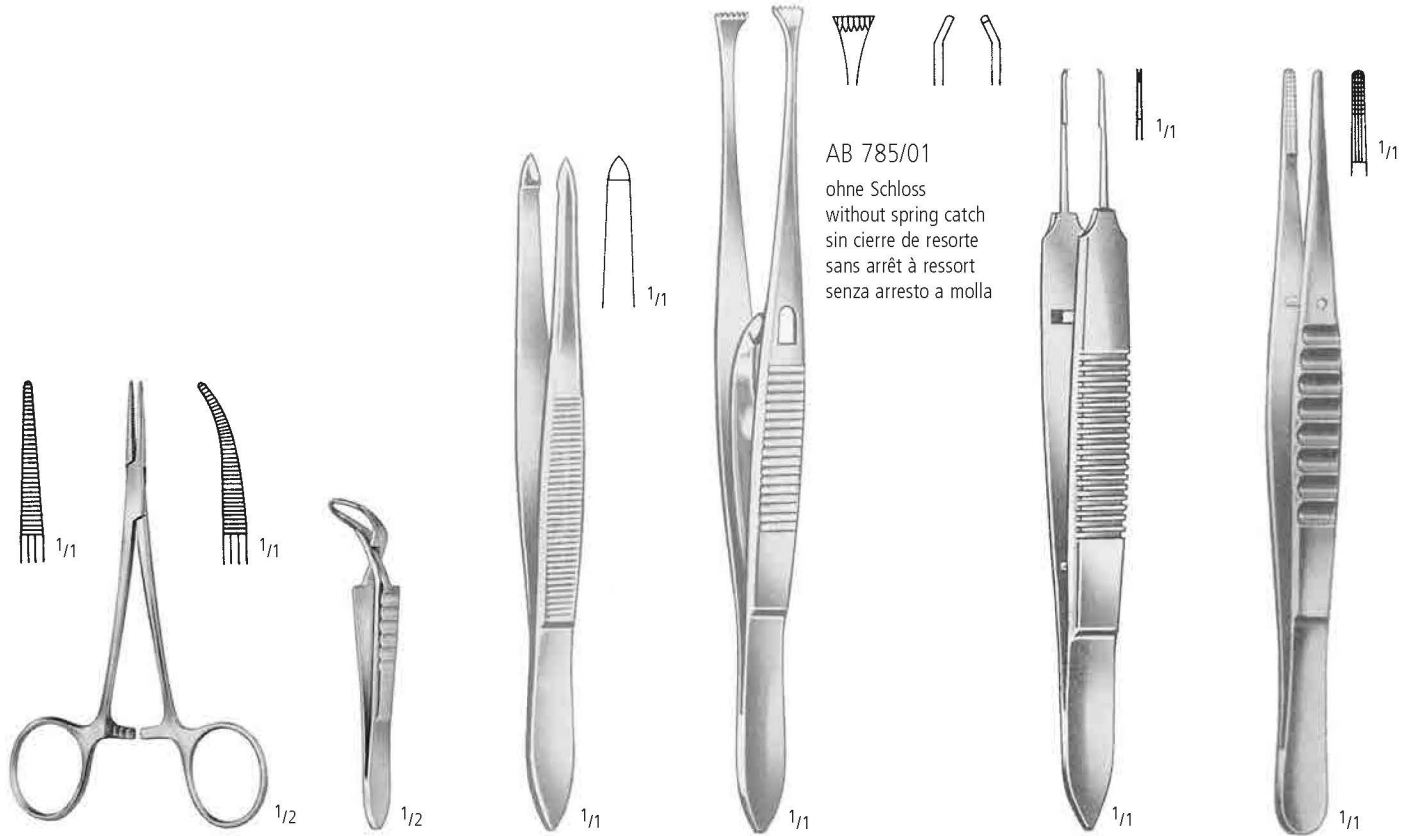

AB 785/01  
ohne Schloss  
without spring catch  
sin cierre de resorte  
sans arrêt à ressort  
senza arresto a molla

**HALSTED-MOSQUITO**  
AA 150/14 AA 151/14  
14,0 cm/5½"

**JONES**  
AA 711/09  
9,0 cm/3½"

**ZIEGLER**  
AB 628/09  
9,0 cm/3½"

**GRAEFE**  
11,0 cm/4⅓"

**CASTROVIEJO 1:2**  
AB 816/01  
0,12 mm  
10,0 cm/4"

**BONACCOLTO**  
AB 824/02  
10,0 cm/4"

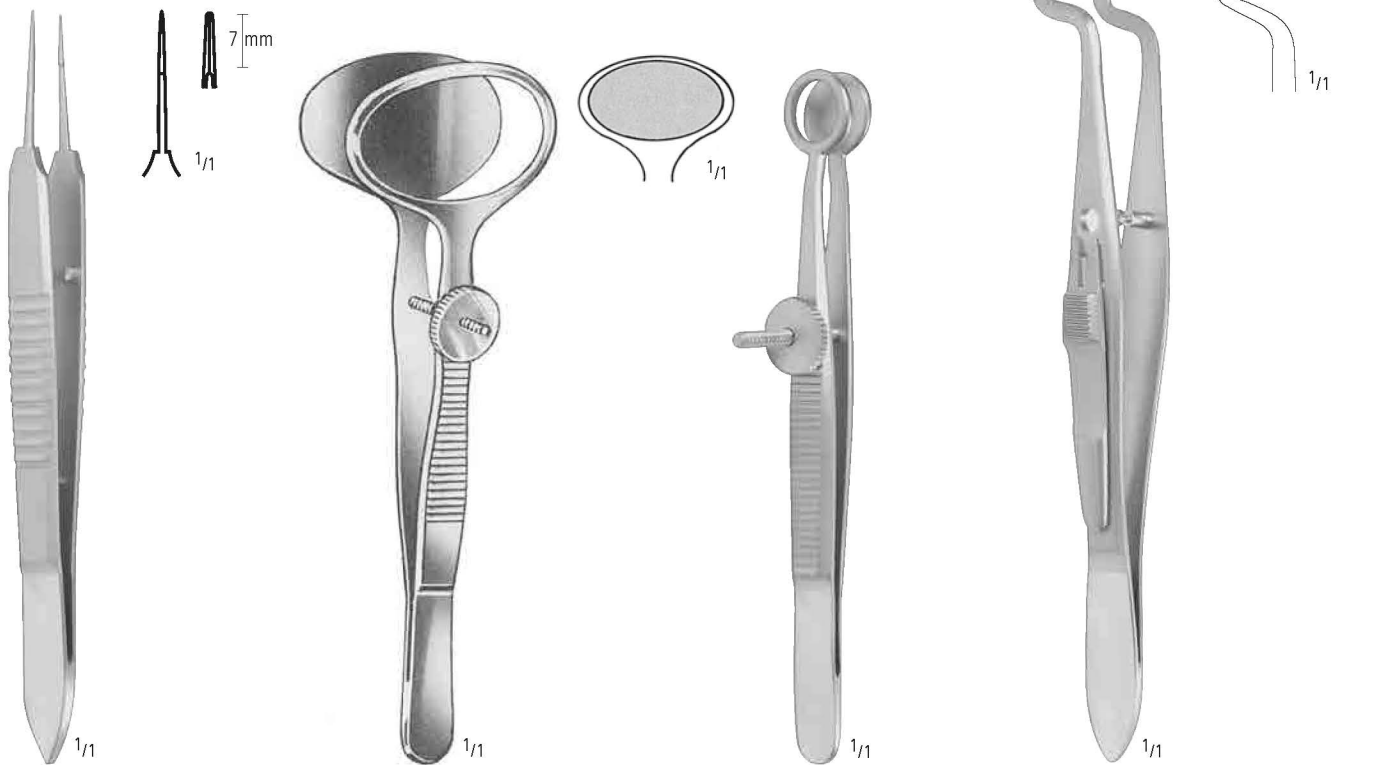

**HARMS**  
AB 829/01  
10,0 cm/4"

**DESMARRES**  
AB 840/01  
9,0 cm/3½"

**LAMPERT**  
AB 841/01  
9,0 cm/3½"

**BERKE**  
AB 844/20  
11,0 cm/4⅓"  
20 mm

Irisscheren  
Iris Scissors  
Tijeras para iridectomía  
Ciseaux à iridectomie  
Forbici per iridectomia

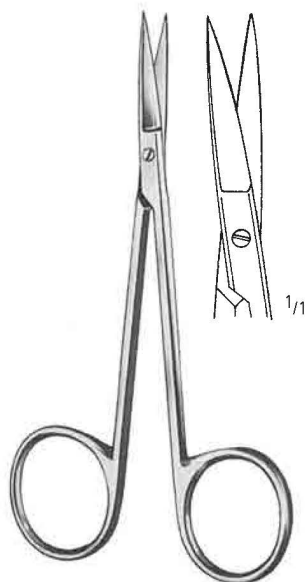

AC 450/10  
10,5 cm/4 1/4"

Sehnenscheren  
Tenotomy Scissors  
Tijeras para tenotomía  
Ciseaux à ténonomie  
Forbici per tenotomia

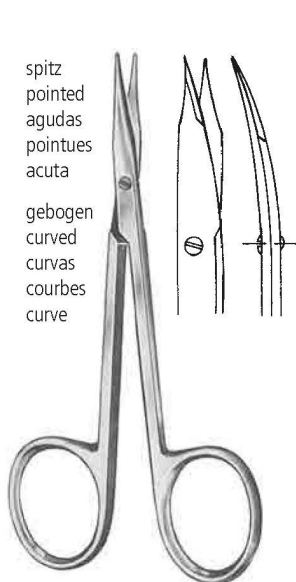

**STEVENS**  
AC 475/10  
10,5 cm/4 1/4"



**WESTCOTT**  
AC 782/11  
11,0 cm/4 1/3"



**WESTCOTT**  
AC 797/01  
11,5 cm/4 1/2"



**CASTROVIEJO**  
AE 663/14  
14,0 cm/5 1/2"

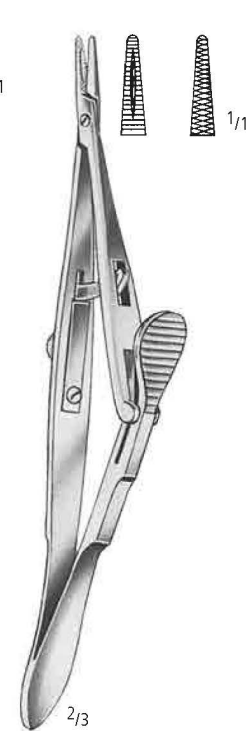

**KALT**  
AE 688/14  
14,0 cm/5 1/2"

spitz  
pointed  
agudas  
pointues  
acuta

gebogen  
curved  
curvas  
courbes  
curve

Messbereich 20 mm  
measuring range 20 mm  
campo de medición 20 mm  
étendue de mesurage 20 mm  
ampiezza di misura 20 mm

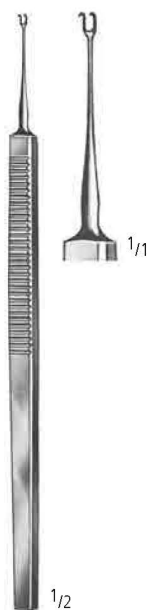

**GUTHRIE**  
AK 074/01  
16,0 cm/6 1/4"



**KNAPP**  
AK 078/13  
13,0 cm/5"



**DESMARRES**  
13,0 cm/5"



**CASTROVIEJO**  
AR 282/20  
8,0 cm/ 3"



**GRAEFE**  
KP 015/01  
13,0 cm/5"  
Fig. 1

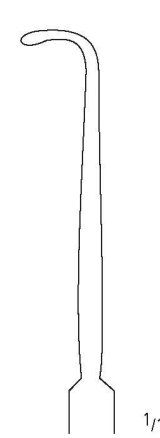

**GRAEFE**  
KP 015/02  
14,0 cm/5 1/2"  
Fig. 2



**JAEGER**  
KP 248/11  
11,0 cm/4 1/2"

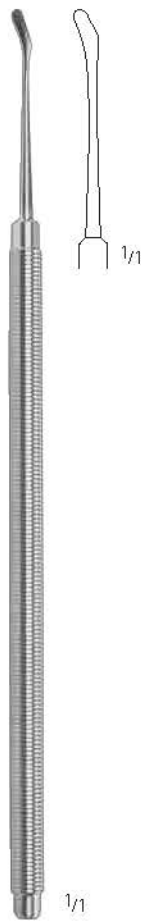

**BONN**  
KP 325/05  
12,5 cm/ 5"  
5 mm



**MEYHOEFER**  
13,0 cm/5"

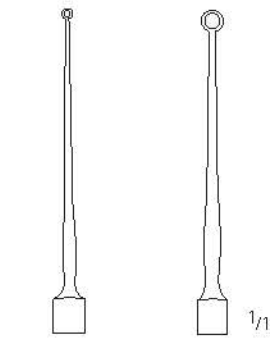

KP 415/10  
Ø 1,0 mm      KP 415/20  
Ø 2,0 mm

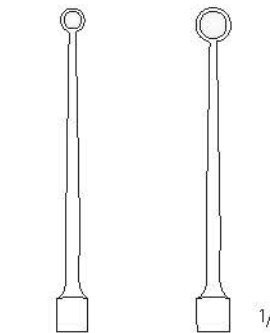

KP 415/25  
Ø 2,5 mm      KP 415/35  
Ø 3,5 mm

Set komplett  
Set complete  
Juego completo  
Jeu complet  
Set completo

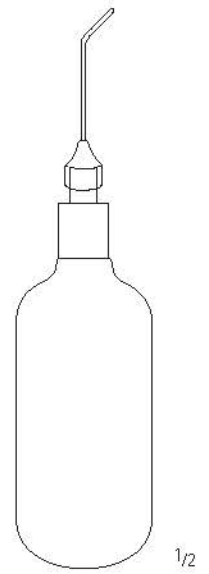

**BISHOP-HARMON**  
KP 700/00

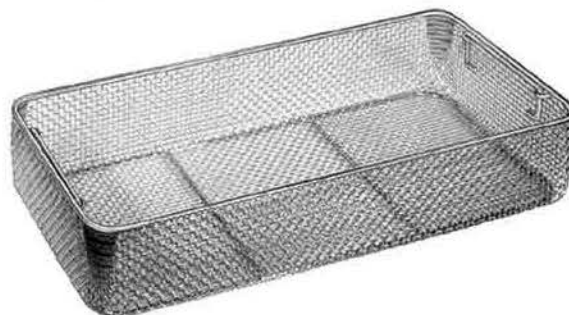

L(mm)	B(mm)	H(mm)	
485	255	50	SK 305/05

**ZS 160/65** PTERYGIUM PTERYGIUM PTERIGIÓN PTÉRYGION PTERIGIO

Contents:		Qty
<b>AB 710/10</b>	GRAEFE IRIS FORCEPS STR SERR. 10,0 CM	1
<b>AB 714/10</b>	GRAEFE IRIS FORCEPS STR 1X2 TEETH 10,0 CM	1
<b>AB 786/02</b>	GREEN FIXATION FORCEPS T-FORM 10,0 CM	1
<b>AB 828/10</b>	PAUFIQUE SUTURE FORCEPS 1X2 TEETH 10,0 CM	1
<b>AC 466/10</b>	IRIS SCISSORS STR W LARGE BOWS 10,0 CM	1
<b>AE 657/14</b>	CASTROVIEJO NH CVD SMOOTH 14,0 CM	1
<b>AK 090/10</b>	DESMARRES RETRACTOR 10 MM 13,0 CM	1
<b>KP 186/08</b>	LANCASTER EYE SPECULA 8,0 CM	1
<b>KP 325/05</b>	BONN SCLERA KNIFE 5MM 12,5 CM	1
<b>SK 105/05</b>	WIRE BASKET, 255 X 245 X 50 MM	

Sterilization Container KYE 200/11, if required



**ZS 160/65** PTERYGIUM PTERYGIUM PTERIGIÓN PTÉRYGION PTERIGIO



AB 710/10  
10,0 cm/4"

**GRAEFE**

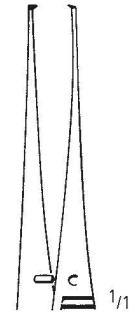
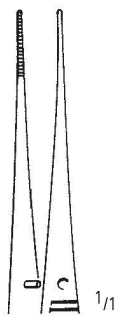

AB 714/10  
10,0 cm/4"



**GREEN**  
AB 786/02  
10,0 cm/4"

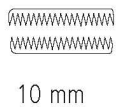

**PAUFIQUE 1:2**  
AB 828/10  
10,0 cm/4"



mit großen Ringen  
with large bows  
con anillos grandes  
avec grands anneaux  
con anelli grandi



AC 466/10  
10,0 cm/4"

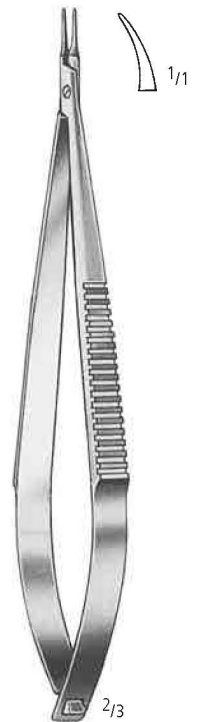

**CASTROVIEJO**  
AE 657/14  
14,0 cm/5 1/2"



**DESMARRES**  
AK 090/10  
13,0 cm/5"

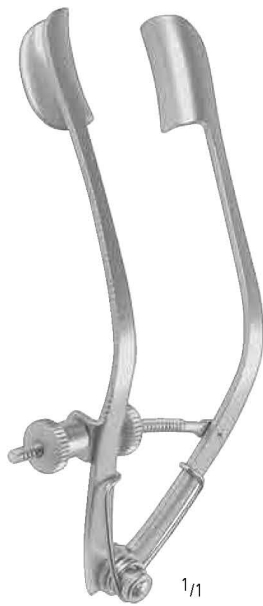

**LANCASTER**  
KP 186/08  
8,0 cm/3 1/4"

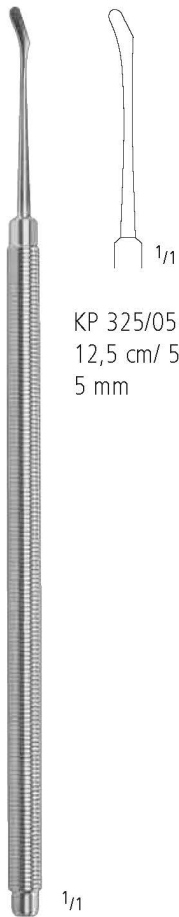

KP 325/05  
12,5 cm/ 5"  
5 mm

**BONN**



L(mm)	B(mm)	H(mm)	
255	245	50	SK 105/05

Contents:		Qty
AA 114/10	HARTMANN FORCEPS STR 10,0 CM	2
AA 115/10	HARTMANN FORCEPS CVD 10,0 CM	2
AA 751/08	BACKHAUS TOWEL FORCEPS 8,0 CM	2
AB 700/05	GRAEFE IRIS FCPS STR.SERRAT. 0,5 MM 7,0 CM	1
AB 816/01	CASTROVIEJO SUTURE FORCEPS 0,12MM 10,0 CM	1
AB 824/02	BONACCOLTO SUTURE FORCEPS 10,0 CM FINE	1
AB 828/10	PAUFIQUE SUTURE FORCEPS 1X2 TEETH 10,0 CM	1
AC 466/10	IRIS SCISSORS STR W LARGE BOWS 10,0 CM	1
AC 477/10	STEVENS TENOTOM.SCS BLUNT CVD 10,5 CM	1
AC 773/10	CASTROVIEJO IRIS SCISSORS 10,0 CM SH	1
AE 661/14	CASTROVIEJO NH CVD RA SMOOTH 14,0 CM	1
AK 077/13	KNAPP DELICATE HOOK SHARP 13,0 CM	1
KA 540/32	MEAD Mallet 320GR MASSIV FERROZ.FAC.17,0 CM	1
KA 800/14	FRIEDMANN RONGEUR FORCEPS 14,0 CM	1
KO 050/01	HARTMANN-HALLE NASAL SPEC.15,0 CM FIG.1	1
KO 275/90	KERRISON ANTRUM RONGEUR FCPS 3X3 MM	1
KO 343/16	JOSEPH SEPTUM ELEVATOR 16,0 CM	1
KO 603/04	FREER CHISELS CURVED 16,0 CM	1
KO 604/04	WEST CHISELS 16,0 CM	1
KO 605/04	WEST GOUGES 16,0 CM	1
KP 114/00	BOWMAN LACRIMAL PROBE POINTED 12,5 CM	1
KP 115/00	BOWMAN LACRIMAL PROBE POINTED 12,5 CM	1
KP 115/12	BOWMAN LACRIMAL PROBE POINTED 12,5 CM	1
KP 115/34	BOWMAN LACRIMAL PROBE POINTED 12,5 CM	1
KP 115/56	BOWMAN LACRIMAL PROBE POINTED 12,5 CM	1
KP 123/14	CASTROVIEJO LACRIMAL DILATOR,14,0 CM D/E	1
KP 135/14	WORST PIGTAIL PROBE 13,5 CM	1
KP 230/08	STEVENSON LACRIMAL SAC RETRACTOR 7,5 CM	1
KP 700/00	BISHOP-HARMON ANTERIOR CHAMBER	1
KP 740/23	ANEL LACRIMAL CANNULA 23G 4,0 CM	1
KP 741/23	LACRIMAL CANNULA 23G 4,0 CM CURVED	1
SK 305/05	WIRE BASKET, 485 X 255 X 50 MM	1

Sterilization Container KYE 200/61, if required



**HARTMANN**  
AA 114/10  
10,0 cm/4"

**HARTMANN**  
AA 115/10  
10,0 cm/4"

**BACKHAUS**  
AA 751/08  
8,0 cm/3"

**GRAEFE**  
0,5 mm  
AB 700/05  
7,0 cm/2¾"

**CASTROVIEJO 1:2**  
AB 816/01  
0,12 mm  
10,0 cm/4"

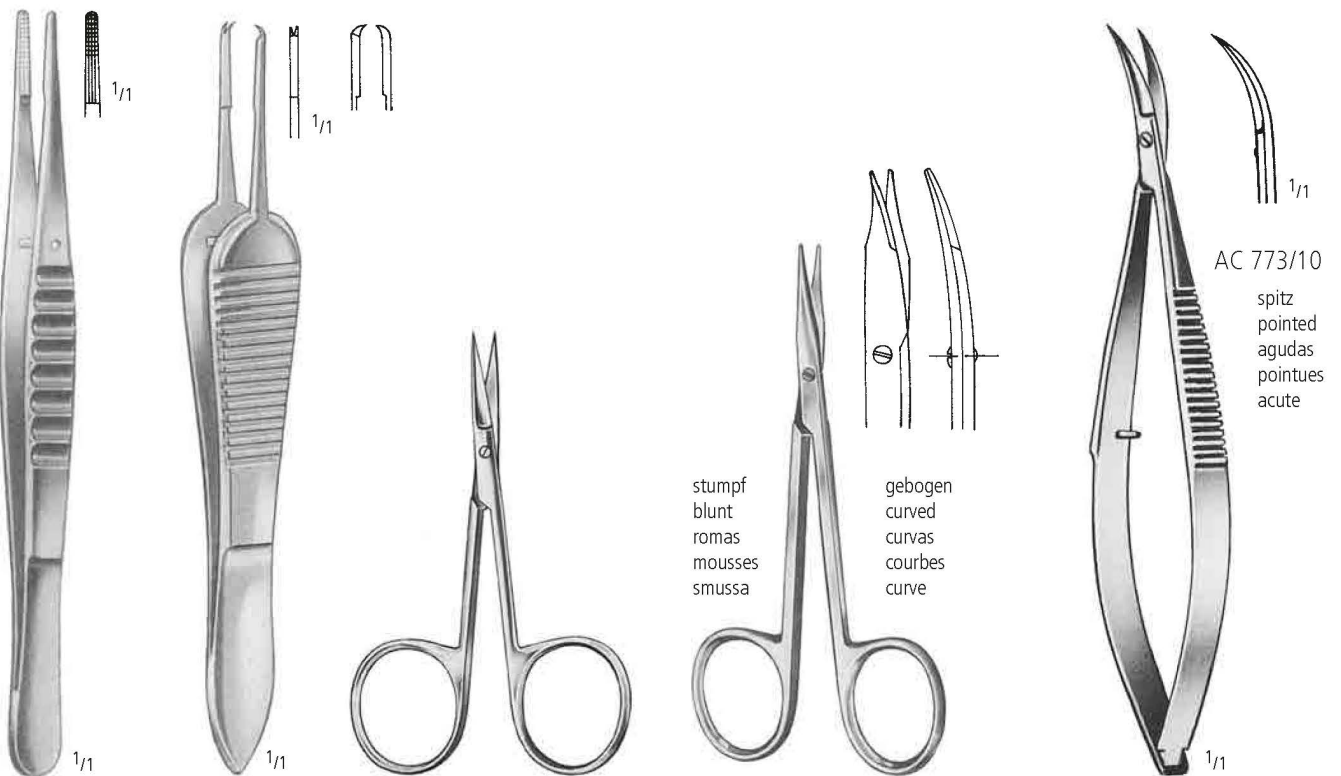

**BONACCOLTO**  
AB 824/02  
10,0 cm/4"

**PAUFIGUE 1:2**  
AB 828/10  
10,0 cm/4"

AC 466/10  
10,0 cm/4"

**STEVENS**  
AC 477/10  
10,5 cm/4¼"

**CASTROVIEJO**  
10,0 cm/4"

stumpf  
blunt  
romas  
mousses  
smussa

gebogen  
curved  
curvas  
courbes  
curve

AC 773/10  
spitz  
pointed  
agudas  
pointues  
acute

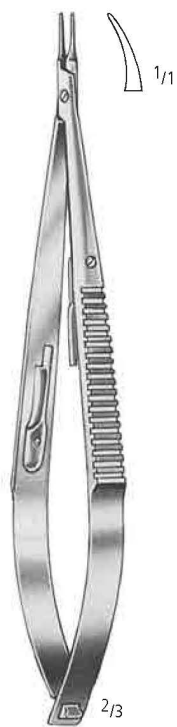

**CASTROVIEJO**  
AE 661/14  
14,0 cm/5 1/2"



**KNAPP**  
AK 077/13  
13,0 cm/5"

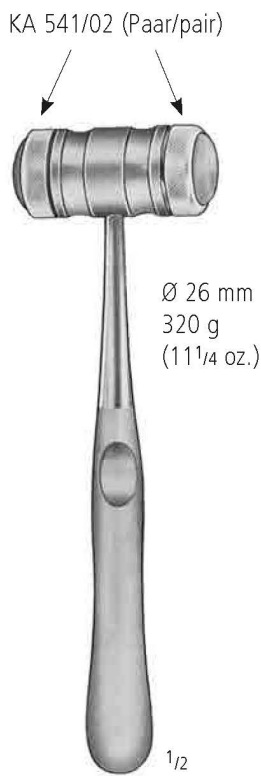

**MEAD**  
KA 540/32  
17,0 cm/6 3/4"

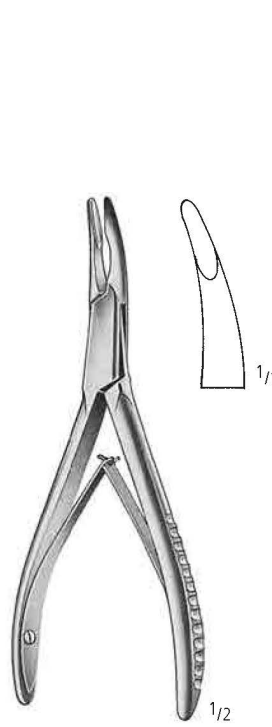

**FRIEDMAN**  
KA 800/14  
14,0 cm/5 1/2"

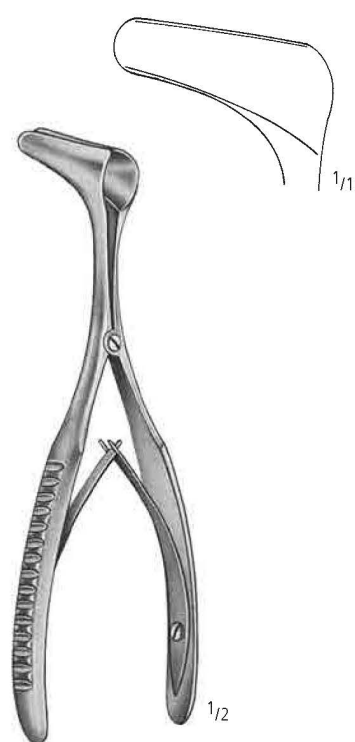

**HARTMANN-HALLE**  
KO 050/01  
15,0 cm/6"



**KERRISON**

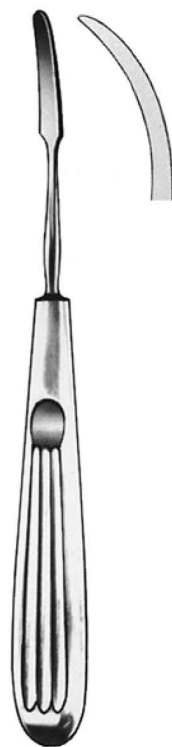

**JOSEPH**  
KO 343/16  
16,0 cm/6 1/4"



**FREER**  
KO 603/04  
16,0 cm/6 1/4"



**WEST**  
KO 604/04  
16,0 cm/6 1/4"



**WEST**  
KO 605/04  
16,0 cm/6 1/4"





geknöpft  
pointed  
con botón  
boutonné  
bottenuto

aus Silber  
Sterling silver  
de plata pura  
en argent pur  
in argento puro

	Fig.	mm Ø
KP 114/00	0000/00	0,4 / 0,6
KP 115/00	00/0	0,7 / 0,8
KP 115/12	1/2	0,9 / 1,1
KP 115/34	3/4	1,3 / 1,4
KP 115/56	5/6	1,5 / 1,6

**BOWMAN**  
12,5 cm/5"



**CASTROVIEJO**  
KP 123/14  
14 cm/5 1/2"

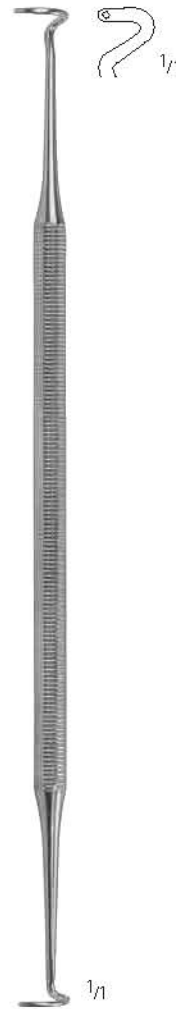

**WORST**  
KP 135/14  
13,5 cm/5 1/4"



**STEVENSON**  
KP 230/08  
7,5 cm/3"

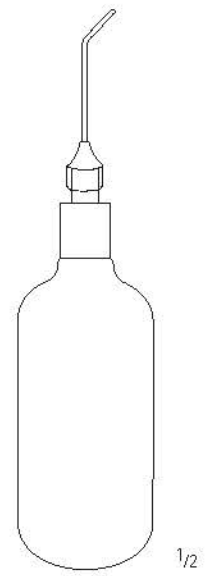

**BISHOP-HARMON**  
KP 700/00

Set komplett  
Set complete  
Juego completo  
Jeu complet  
Set completo

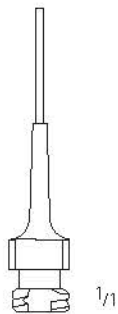

**ANEL**  
KP 740/23  
4,0 cm/1 1/2"  
23G

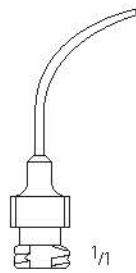

KP 741/23  
3,5 cm/1 1/2"  
23G

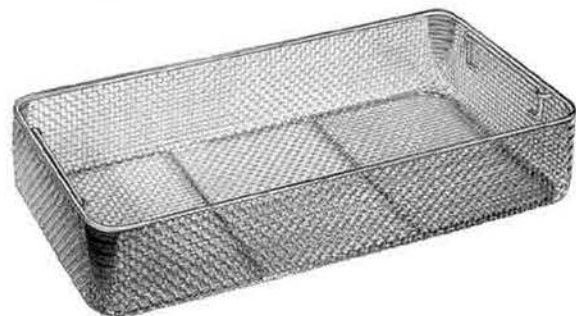

L(mm)	B(mm)	H(mm)	
485	255	50	SK 305/05



**ZS 160/75** LASIK LASIK LASIK LASIK LASIK

Contents:		Qty
<b>AB 819/02</b>	MCPHERSON TYING FORCEPS ANGLED 10,5 CM	1
<b>KP 210/02</b>	LIEBERMAN EYE SPECULA 15 MM K-SHAPE 8,0 CM	1
<b>KP 211/08</b>	LIEBERMAN EYE SPECULA 15 MM 8,0 CM ASP.	1
<b>KP 270/10</b>	LASIK FLAP SMOOTHER 10,0 CM	1
<b>KP 487/14</b>	CASTROVIEJO CYCLODIALYSIS SPATULA 13,5 CM	1
<b>KP 489/12</b>	BARRAQUER-FINO CYCLODIALYSIS SPATULA 11,5 CM	1
<b>KP 516/11</b>	LU CORNEAL MARKER LASIK Ø 8,5MM 10,5 CM	1
<b>KP 550/12</b>	THORNTON FIXATION RING FG-HINGE Ø 13,0 MM	1
<b>KP 701/19</b>	BISHOP-HARMON IRRIGATION CANNULA 19G 4,0 CM	1
<b>KP 731/27</b>	SAUTTER AIR INJECTION CANNULA 27G 3,5 CM	1
<b>SK 105/05</b>	WIRE BASKET, 255 X 245 X 50 MM	1

Sterilization Container KYE 200/11, if required



**McPHERSON**  
AB 819/02  
10,0 cm/4"



**LIEBERMAN**  
KP 210/02  
8,0 cm/3 1/4"  
**B** = 15 mm



**LIEBERMAN**  
KP 211/08  
8,0 cm/3 1/4"  
**B** = 15 mm



**LASIK**  
KP 270/10  
10,0 cm/4"

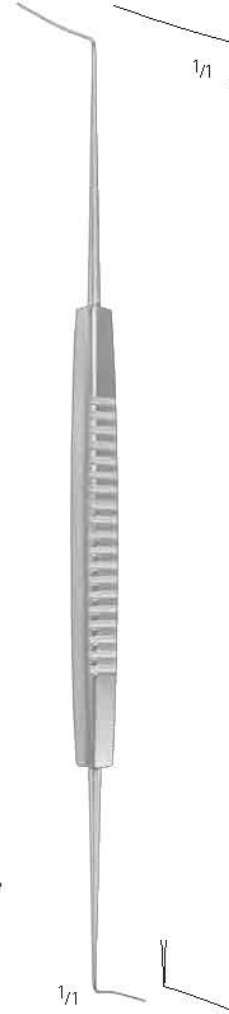

**CASTROVIEJO**  
KP 487/14  
13,5 cm/5 1/4"  
0,5 x 10/16 mm



**BARRAQUER-FINO**  
KP 489/12  
11,5 cm/4 1/2"  
0,25 x 12 mm

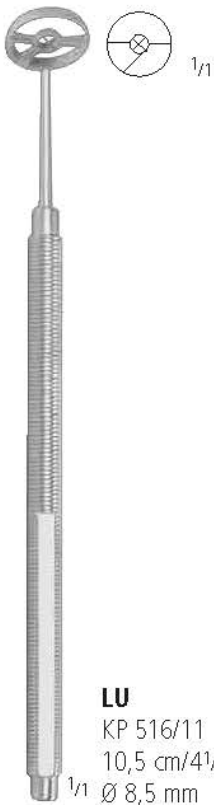

**LU**  
KP 516/11  
10,5 cm/4 1/4"  
Ø 8,5 mm

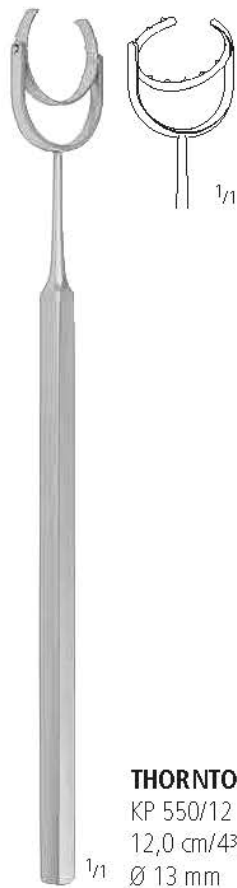

**THORNTON**  
KP 550/12  
12,0 cm/4 3/4"  
Ø 13 mm

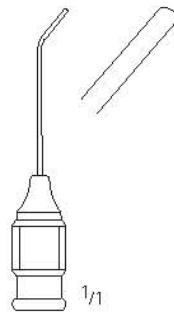

**BISHOP-HARMON**  
KP 701/19  
4,0 cm/1 1/2"  
19G

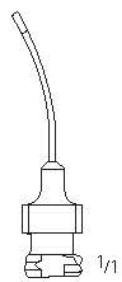

**SAUTTER**  
KP 731/27  
3,5 cm/1 1/2"  
27G



L(mm)	B(mm)	H(mm)	
255	245	50	SK 105/05

Contents:		Qty
AB 752/07	BARRAQUER-KATZIN IRIS FORCEPS 7,0 CM	1
AB 820/10	KELMAN-MCPHERSON TYING FORCEPS 10,0 CM	1
KP 154/04	BARRAQUER PHACO EYE SPECULA 4,0 CM	1
KP 375/02	PREMIUM DIAMOND KNIFE 1,0 CM 45°	1
KP 500/30	HOFFER OPTICAL ZONE MARKER 3,00 MM 10,0 CM	1
KP 500/32	HOFFER OPTICAL ZONE MARKER 3,25 MM 10,0 CM	1
KP 500/40	HOFFER OPTICAL ZONE MARKER 4.00 MM 10,0 CM	1
KP 500/50	HOFFER OPTICAL ZONE MARKER 5.00MM 10,0 CM	1
KP 500/70	HOFFER OPTICAL ZONE MARKER 7.00MM 10,0 CM	1
KP 535/12	ANIS SUTURE PLACEMENT MARKER 8 BLADES	1
KP 548/50	DEITZ DEPTH GAUGE 0,50 MM 9,5 CM	1
KP 548/55	DEITZ DEPTH GAUGE 0,55 MM 9,5 CM	1
KP 550/12	THORNTON FIXATION RING FG-HINGE Ø 13,0 MM	1
KP 731/27	SAUTTER AIR INJECTION CANNULA 27G 3,5 CM	2
SK 105/05	WIRE BASKET, 255 X 245 X 50 MM	1

Sterilization Container KYE 200/11, if required



**BARRAQUER-KATZIN 1:2 (Colibri)**  
AB 752/07  
7,0 cm/2<sup>3</sup>/<sub>4</sub>"

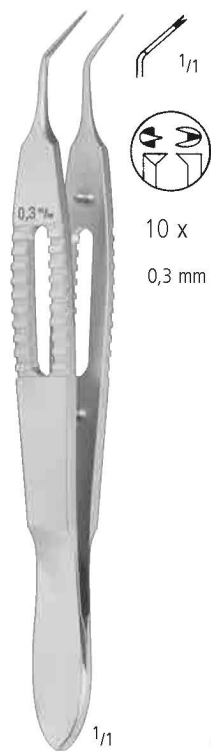

**BARRAQUER PHAKO**  
KP 154/04  
4,0 cm/1<sup>1</sup>/<sub>2</sub>"



mit Mikrometer  
with micrometer  
con micrómetro  
avec micromètre  
con micrometro

- Ø 3,00 mm
- Ø 3,25 mm
- Ø 4,00 mm
- Ø 5,00 mm
- Ø 7,00 mm



**HOFFER**  
10,0 cm/4"

**KELMAN-McPHERSON 1:2**  
AB 820/10  
10,0 cm/4"

KP 375/02



**ANIS**  
KP 535/12  
12,0 cm/4<sup>3</sup>/<sub>4</sub>"

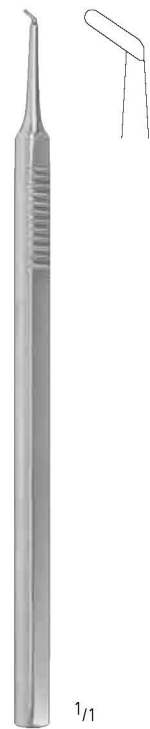

**DEITZ**  
9,5 cm/3<sup>3</sup>/<sub>4</sub>"  
KP 548/50  
0,50 mm  
KP 548/55  
0,55 mm

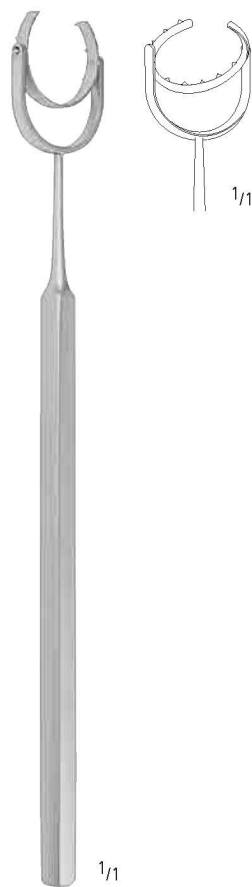

**THORNTON**  
KP 550/12  
12,0 cm/4<sup>3</sup>/<sub>4</sub>"  
Ø 13 mm

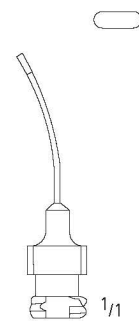

**SAUTTER**  
KP 731/27  
3,5 cm/1<sup>1</sup>/<sub>2</sub>"  
27G



L(mm)	B(mm)	H(mm)	
255	245	50	SK 105/05

Contents:		Qty
AA 060/03	DIEFFENBACH BULLDOG CLAMPS STR 3,5 CM	2
AA 114/10	HARTMANN FORCEPS STR 10,0 CM	2
AA 150/12	HALSTED-MOSQUITO FCPS STR 12,5 CM	2
AA 711/09	JONES TOWEL FORCEPS 9,0 CM	2
AA 751/13	BACKHAUS TOWEL FORCEPS 13,0 CM	2
AB 710/10	GRAEFE IRIS FORCEPS STR SERR. 10,0 CM	1
AB 750/07	BARRAQUER-KATZIN FIX.FCPS 1X2 T. 7,0 CM	1
AB 816/01	CASTROVIEJO SUTURE FORCEPS 10,0 CM	2
AB 824/02	BONACCOLTO SUTURE FORCEPS 10,0 CM FINE	1
AB 825/02	BONN SUTURE FORCEPS 10,0 CM ULRTA FINE	2
AB 848/11	FAULKNER LENS HOLDING FORCEPS 11,0 CM	1
AC 466/10	IRIS SCISSORS STR W LARGE BOWS 10,0 CM	1
AC 467/10	IRIS SCISSORS CVD W LARGE BOWS 10,0 CM	1
AC 474/11	STEVENS TENOTOM.SCS.STR POINTED 11,5 CM	1
AC 776/01	VANNAS MOD.TÜBINGEN STRAIGHT 8,5 CM	1
AC 780/11	WESTCOTT TENOTOMY SCS.POINTED 11,0 CM	1
AE 657/14	CASTROVIEJO NH CVD SMOOTH 14,0 CM	1
AE 660/14	CASTROVIEJO NH STR RA SMOOTH 14,0 CM	1
AR 282/20	CASTROVIEJO CIRCLE 8,0 CM STRAIGHT	1
KP 002/12	JAMESON MUSCLE HOOK 12,0 CM	2
KP 010/14	GASS RETINAL DETACHMENT HOOK 14,0 CM	2
KP 211/08	LIEBERMAN EYE SPECULA 15 MM 8,0 CM ASP.	1
KP 261/15	SAUTTER ORBITAL SPATUL MEDIUM 15,0 CM	1
KP 262/13	ARRUGA PROTECTOR 13,0 CM	1
KP 354/12	FOREIGN BODY NEEDLE STRAIGHT 12,0 CM	1
KP 390/00	VITRECTOMY SCISSORS STRAIGHT SMOOTH 0°	1
KP 394/00	VITRECTOMY GRASPING FCPS STRAIGHT SMOOTH	1
KP 700/00	BISHOP-HARMON ANTERIOR CHAMBER	1
KP 760/21	INJECTION CANNULA 21G 4,5 CM	1
SK 305/05	WIRE BASKET, 485 X 255 X 50 MM	1

Sterilization Container KYE 200/61, if required





**DIEFFENBACH**  
AA 060/03  
3,5 cm/1 1/2"

**HARTMANN**  
AA 114/10  
10,0 cm/4"

**HALSTED-MOSQUITO**  
AA 150/12  
12,5 cm/5"

**JONES**  
AA 711/09  
9,0 cm/3 1/2"

**BACKHAUS**  
AA 751/13  
13,0 cm/5"

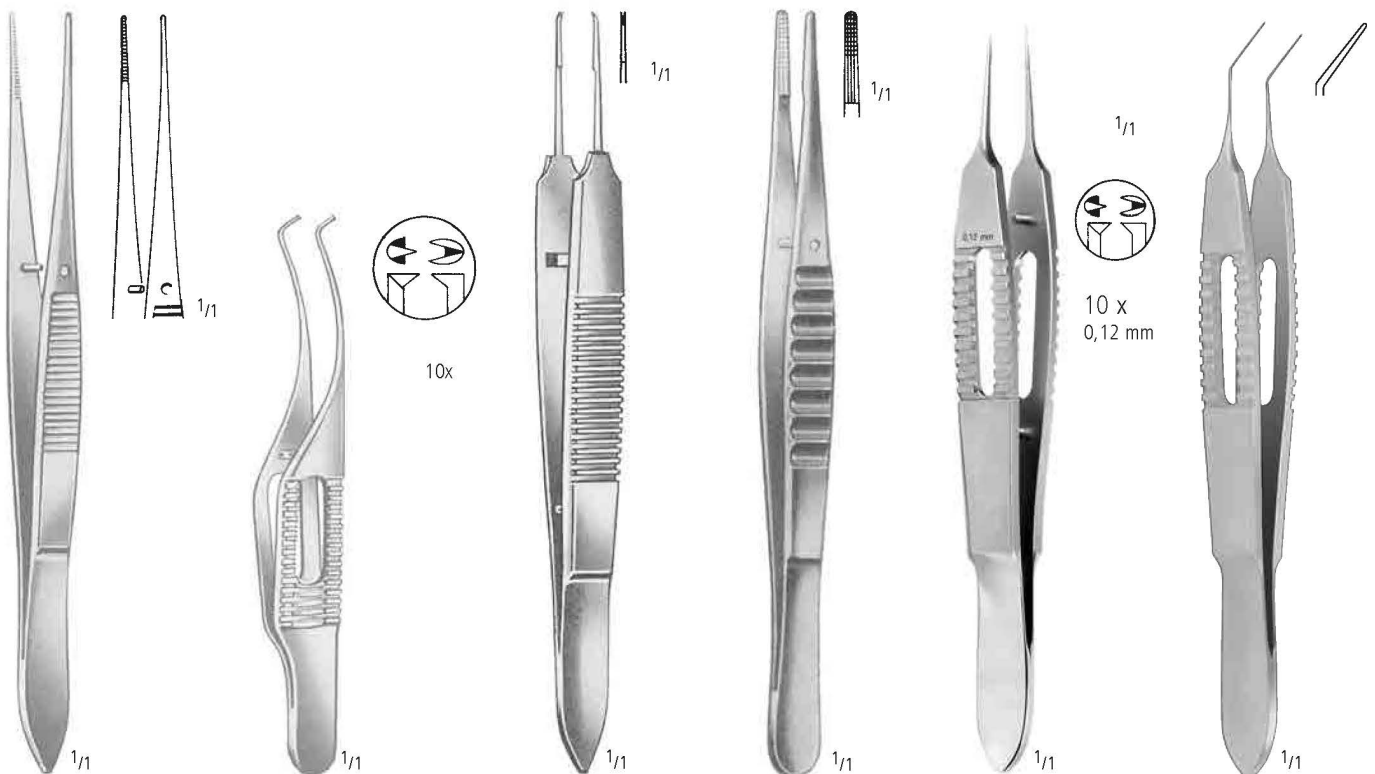

**GRAEFE**  
AB 710/10  
10,0 cm/4"

**BARRAQUER-KATZIN 1:2 (Colibri)**  
AB 750/07  
7,0 cm/2 3/4"

**CASTROVIEJO 1:2**  
AB 816/01  
0,12 mm  
10,0 cm/4"

**BONACCOLTO**  
AB 824/02  
10,0 cm/4"

**MOD. BONN**  
AB 825/02  
10,0 cm/4"

**FAULKNER**  
AB 848/11  
11,0 cm/4 1/3"

ZS 160/85

VITREKTOMIE (PARS PLANA)  
VITRECTOMIE (PARS PLANA)

VITRECTOMY (PARS PLANA)  
VITRECTOMIA PARS-PLANA

VITRECTOMÍA PARS-PLANA

mit großen Ringen  
with large bows  
con anillos grandes  
avec grands anneaux  
con anelli grandi

spitz  
pointed  
agudas  
pointues  
acuta

gerade  
straight  
rectas  
droits  
rette

gerade  
straight  
rectas  
droits  
rette

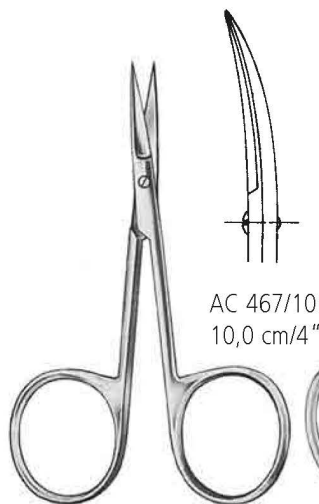

AC 467/10  
10,0 cm/4"

AC 466/10  
10,0 cm/4"

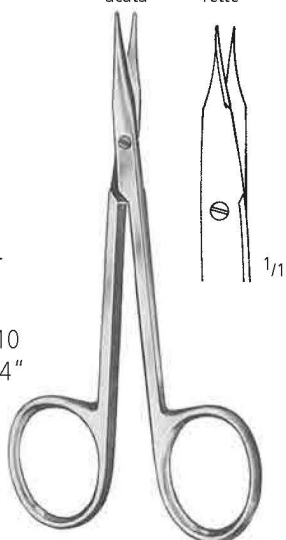

**STEVENS**  
AC 474/11  
11,5 cm/4 1/2"

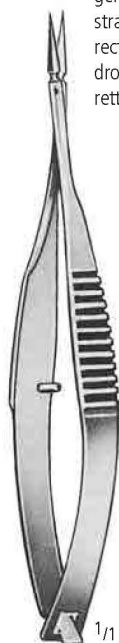

**VANNAS MOD. TÜBINGEN**  
AC 776/01  
8,5 cm/3 1/3"



**WESTCOTT**  
AC 780/11  
11,0 cm/4 1/3"

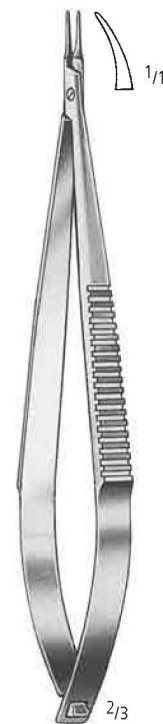

**CASTROVIEJO**  
AE 657/14  
14,0 cm/5 1/2"



**CASTROVIEJO**  
AE 660/14  
14,0 cm/5 1/2"

Messbereich 20 mm  
measuring range 20 mm  
campo de medición 20 mm  
étendue de mesure 20 mm  
ampiezza di misura 20 mm



**CASTROVIEJO**  
AR 282/20  
8,0 cm/ 3"



**JAMESON**  
KP 002/12  
12,0 cm/4 3/4"

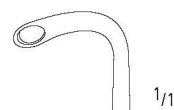

**GASS**  
KP 010/14  
14,0 cm/5 1/2"

B



**LIEBERMAN**  
KP 211/08  
8,0 cm/3 1/4"  
B = 15 mm



**SAUTTER**  
KP 261/15  
15,0 cm/6"



**ARRUGA**  
KP 262/13  
13,0 cm/5"

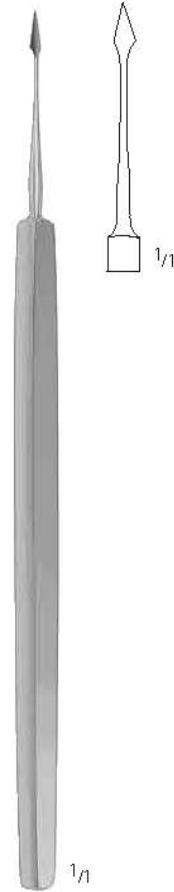

KP 354/12  
12,0 cm/ 4 3/4"



KP 390/00  
0°

ohne Spülung  
without irrigation  
sin irrigadòn  
sans irrigation  
senza irrigazione

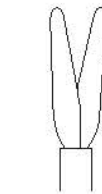

KP 394/00



**BISHOP-HARMON**  
KP 700/00

Set komplett  
Set complete  
Juego completo  
Jeu complet  
Set completo

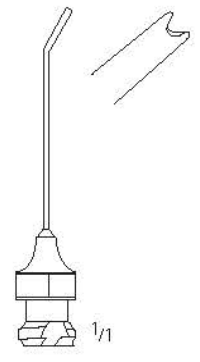

KP 760/21  
4,5 cm/2"  
21G

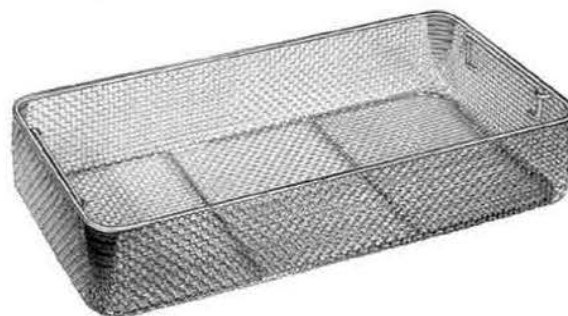

L(mm)	B(mm)	H(mm)	
485	255	50	SK 305/05

KLEMMEN  
HEMOSTATS  
PINZAS HEMOSTATICAS  
PINCES HEMOSTATIQUES  
PINZE EMOSTATICHE

AA

nopa<sup>®</sup> instruments

Weitere Klemmen finden Sie in unserem Katalog „Allgemeines Instrumentarium“ in Gruppe AA.

For further hemostats kindly refer to our catalogue „General Instruments“, section AA.

Para pinzas hemostaticas adicionales, por favor consulte nuestro catálogo de „Instrumental de uso general“, grupo AA.

Pour des pinces hemostatiques supplémentaires, consultez notre catalogue „Instrumentation Generale“, section AA.

Per gli altri pinze emostatiche, consultare il nostro catalogo „Strumentazione Generale“, gruppo AA.







KLEMMEN HEMOSTATS PINZAS HEMOSTATICAS PINCES HEMOSTATIQUES PINZE EMOSTATICHE

Bulldogklemmen, Anlegezangen  
 Bulldog Clamps, Setting Forceps  
 Clamps Bulldog, Pinza para poner  
 Clamps Bulldog, Pince à poser  
 Pinze Bulldog, Pinza per posizionare

AA

AB

AC

AD

AE

AK

AR

KA

KM

KO

KP

XR



1/1

**DIEFFENBACH**

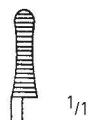

1/1

AA 060/03  
3,5 cm/1 1/2"

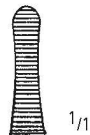

1/1

AA 060/05  
5,0 cm/2"

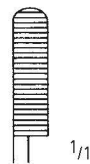

1/1

AA 060/06  
6,0 cm/2 1/2"

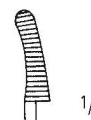

1/1

AA 061/03  
3,5 cm/1 1/2"



1/1

AA 061/05  
5,0 cm/2"

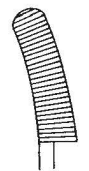

1/1

AA 061/06  
6,0 cm/2 1/2"



1/2

**JOHNS-HOPKINS**

AA 069/24  
24,5 cm/9 3/4"



1/1

**JOHNS-HOPKINS**

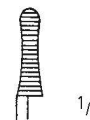

1/1

AA 070/04  
4,0 cm/1 1/2"

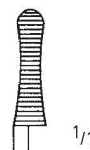

1/1

AA 070/05  
5,0 cm/2"

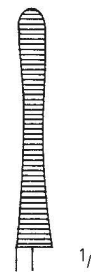

1/1

AA 070/06  
6,5 cm/2 1/2"

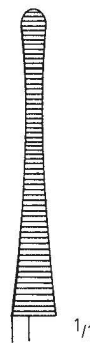

1/1

AA 070/07  
7,5 cm/3"

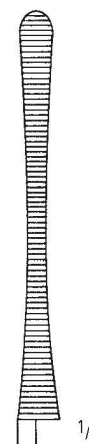

1/1

AA 070/09  
9,0 cm/3 1/2"



1/1

AA 071/06  
6,5 cm/2 1/2"



1/1

AA 071/07  
7,5 cm/3"



1/1

AA 071/09  
9,0 cm/3 1/2"

Arterienklemmen  
 Artery Forceps  
 Pinzas hemostáticas  
 Pincas hémostatiques  
 Pinze emostatiche

# T = TITAN

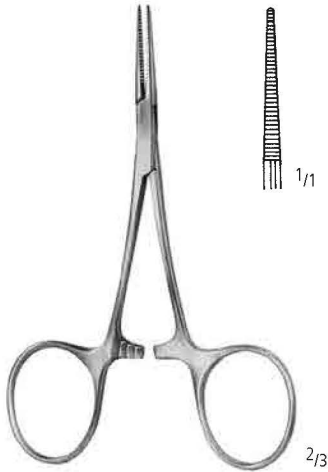

**HARTMANN**  
 AA 114/10  
 AA 114/10 T  
 10,0 cm/4"

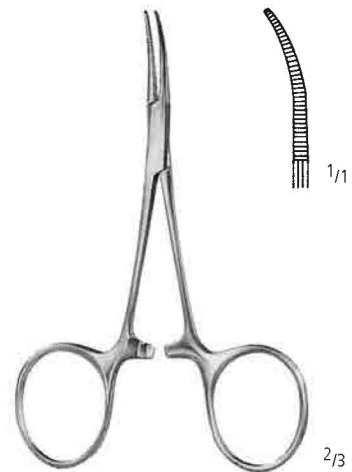

**HARTMANN**  
 AA 115/10  
 AA 115/10 T  
 10,0 cm/4"

**WILLIAM STEWART HALSTED**  
 was professor of surgery in the Johns Hopkins University.  
 In 1890 he had bronze casts made of his own hands. On these casts the first surgical rubber gloves were moulded.

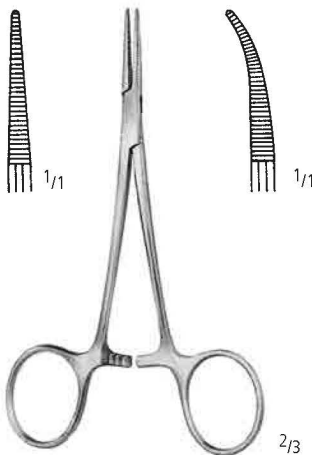

**HALSTED-MOSQUITO**  
 AA 150/12      AA 151/12      12,5 cm/5"  
 AA 150/12 T      AA 151/12 T      12,5 cm/5"  
 AA 150/14      AA 151/14      14,0 cm//5 1/2"

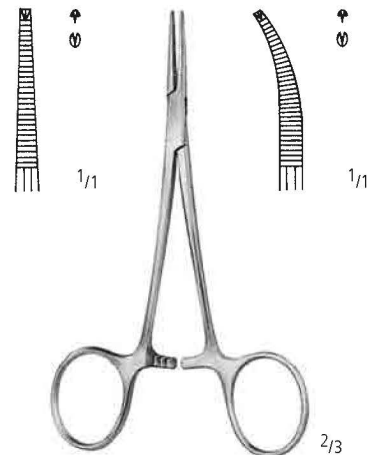

**HALSTED-MOSQUITO 1:2**  
 AA 152/12      AA 153/12  
 AA 152/12 T      AA 153/12 T  
 AA 152/14      AA 153/14

Tuchklemmen  
Towel Forceps  
Pinzas para compresas, Pinzas de campo  
Pinces à champs, Pinces à compresses  
Pinze per fissare le compresse (Fissarele)

AA

AB

AC

AD

AE

AK

AR

KA

KM

KO

KP

XR



**SCHAEDEL**  
AA 710/09  
9,0 cm/3 1/2"



**JONES**  
5,0 cm/2"  
9,0 cm/3 1/2"  
AA 711/05  
AA 711/09



AA 749/11  
11,0 cm/4 1/2"

mit Schlauch- oder Kabelhalter  
with clip for tubing or cable  
con porta-tubo o porta-cable  
avec clamp porte-tube ou porte-  
-corton d'alimentation  
con porta tubo o porta cavo

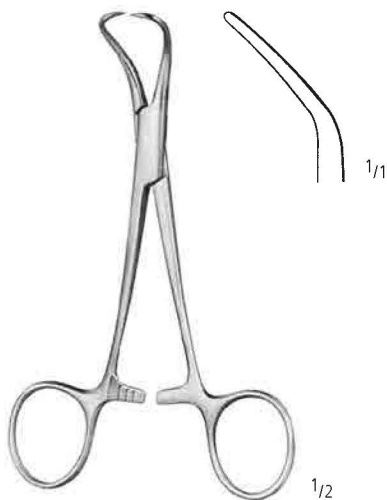

**BACKHAUS**  
8,0 cm/3 1/4"  
11,0 cm/4 1/2"  
13,0 cm/5"  
15,0 cm/6"  
AA 751/08  
AA 751/11  
AA 751/13  
AA 751/15



**ROEDER**  
13,0 cm/5"  
15,0 cm/6"  
AA 761/13  
AA 761/15

Tuchklemmen  
Towel Forceps  
Pinzas para compresas, Pinzas de campo  
Pinces à champs, Pinces à compresses  
Pinze per fissare le compresse (Fissarele)

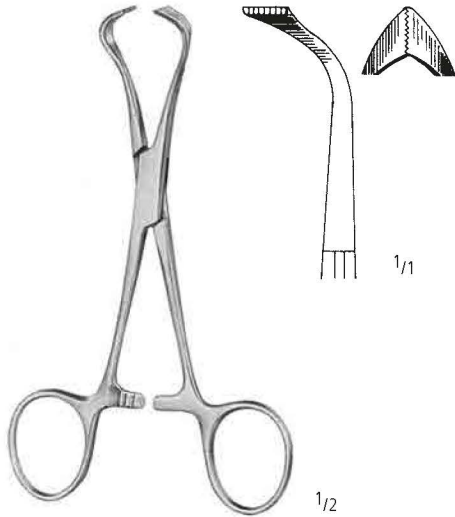

**LORNA**

10,0 cm/4" AA 763/10  
13,0 cm/5" AA 763/13

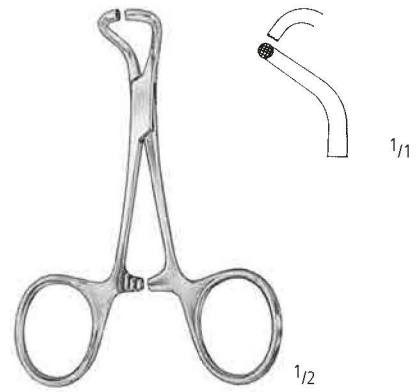

**TOHOKU-JAPAN**

10,0 cm/4" AA 764/10  
13,0 cm/5" AA 764/13

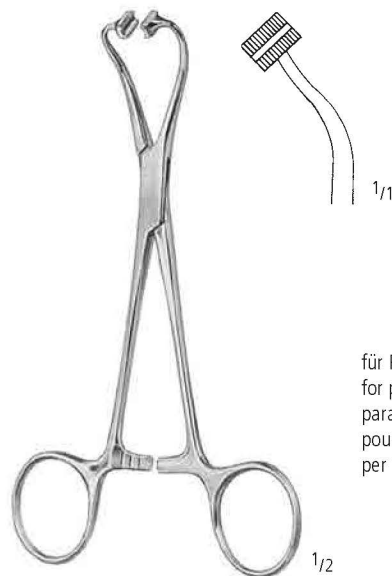

für Papiertücher  
for paper tissues  
para servilletas de papel  
pour serviettes en papier  
per tessuti di carta

**PEERS**

AA 765/14  
14,5 cm/5<sup>3</sup>/<sub>4</sub>"

PINZETTEN

FORCEPS

PINZAS

PINCES

PINZE

AB

nopa<sup>®</sup> instruments

Weitere Pinzetten finden Sie in unserem Katalog „Allgemeines Instrumentarium“ in Gruppe AB.

For further forceps kindly refer to our catalogue „General Instruments“, section AB.

Para pinzas adicionales, por favor consulte nuestro catálogo de „Instrumental de uso general“, grupo AB.

Pour des pinces supplémentaires, consultez notre catalogue „Instrumentation Generale“, section AB.

Per gli altri pinze, consultare il nostro catalogo „Strumentazione Generale“, gruppo AB.





Anatomische Pinzetten, Chirurgische Pinzetten  
 Dressing Forceps, Tissue Forceps  
 Pinzas de disección, Pinzas de disección con dientes  
 Pincés à dissection, Pincés a griffes  
 Pinze anatomiche per dissezione, Pinze chirurgiche a denti di topo

## T = TITAN

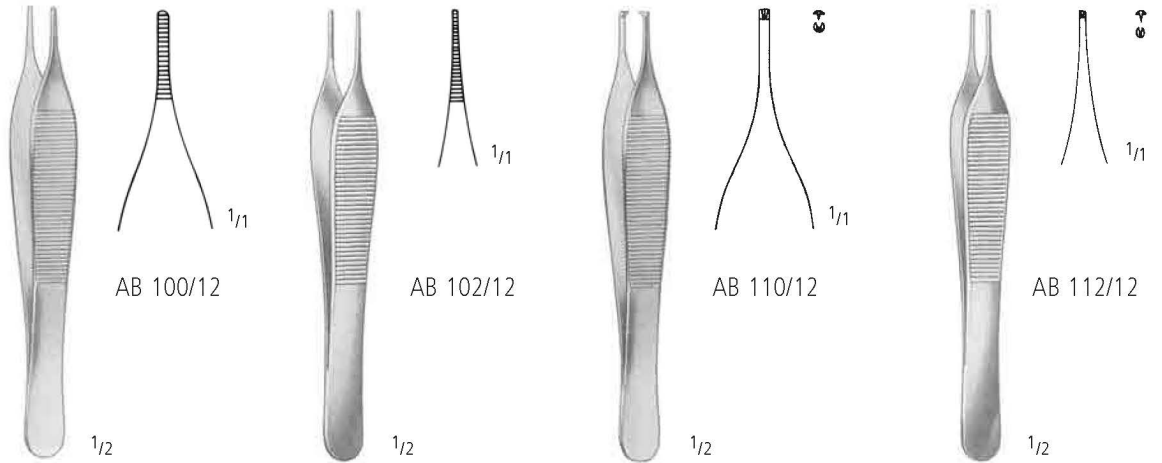

**ADSON**

AB 100/12  
 AB 100/12 T  
 AB 100/15

12,0 cm/4<sup>3</sup>/<sub>4</sub>"  
 12,0 cm/4<sup>3</sup>/<sub>4</sub>"  
 15,0 cm/6"

**MICRO-ADSON**

AB 102/12  
 AB 102/15

**ADSON 1:2**

AB 110/12  
 AB 110/12 T  
 AB 110/15

**MICRO-ADSON 1:2**

AB 112/12  
 AB 112/15

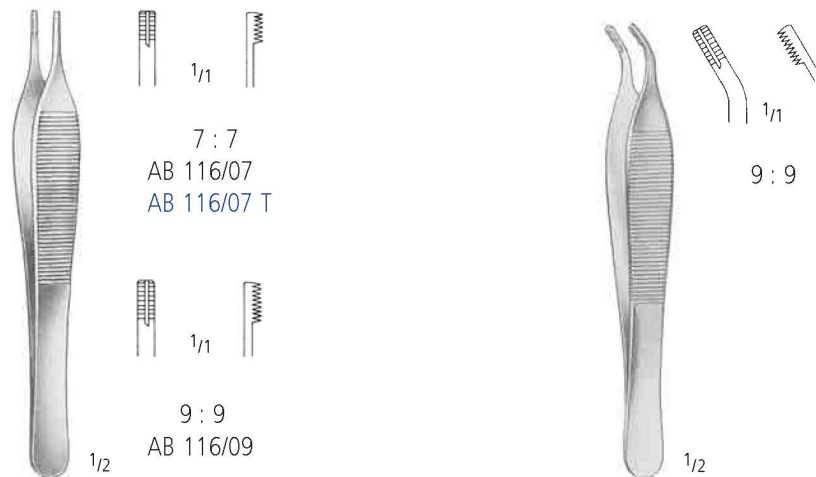

**ADSON-BROWN**

12,0 cm/4<sup>3</sup>/<sub>4</sub>"

**ADSON-BROWN**

AB 117/09  
 12,0 cm/4<sup>3</sup>/<sub>4</sub>"

PINZETTEN FORCEPS PINZAS PINCES PINZE

Cilienpinzetten  
Cilia Forceps  
Pinzas de depilatorias  
Pincas à épiler les cils  
Pinze depilatorie



**LITTAUER**  
AB 620/08  
8,5 cm/3 1/2"



AB 621/09  
9,0 cm/3 1/2"



**DOUGLAS**  
AB 624/09  
9,0 cm/3 1/2"



**BEER**  
AB 626/09  
9,0 cm/3 1/2"



**ZIEGLER**  
AB 628/09  
9,0 cm/3 1/2"



**BARRAQUER**  
AB 633/10  
10,5 cm/4 1/4"



**GRADLE**  
AB 635/09  
9,5 cm/3 3/4"

AA

AB

AC

AD

AE

AK

AR

KA

KM

KO

KP

XR

**AB** PINZETTEN FORCEPS PINZAS PINCES PINZE

Irispinzetten  
Iris Forceps  
Pinzas para iris  
Pincès à iris  
Pinze per iride



AB 700/07



AB 701/07



AB 702/07

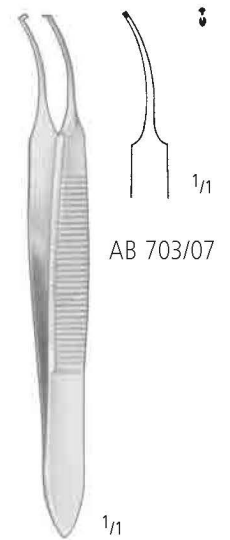

AB 703/07

**GRAEFE**  
7,0 cm/2¾"

**GRAEFE**  
7,0 cm/2¾"

**GRAEFE 1:2**  
7,0 cm/2¾"

**GRAEFE 1:2**  
7,0 cm/2¾"

0,5 mm AB 700/05  
0,7 mm AB 700/07  
1,0 mm AB 700/10

AB 701/05  
AB 701/07  
AB 701/10

AB 702/05  
AB 702/07  
AB 702/10

AB 703/05  
AB 703/07  
AB 703/10



7,0 cm/2¾" AB 710/07  
10,0 cm/4" AB 710/10

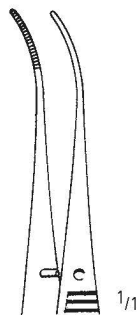
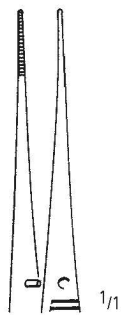

AB 711/07  
AB 711/10

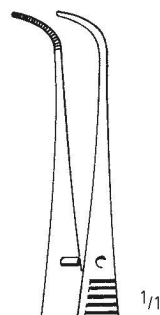

AB 713/07  
AB 713/10

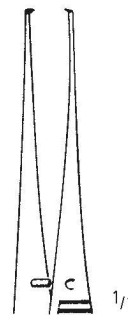

AB 714/07  
AB 714/10

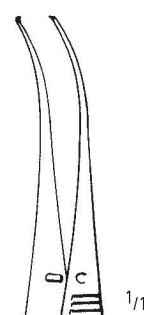

AB 715/07  
AB 715/10

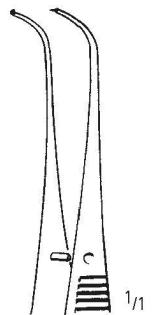

AB 717/07  
AB 717/10

**GRAEFE**

PINZETTEN FORCEPS PINZAS PINCES PINZE

Irispinzetten  
Iris Forceps  
Pinzas para iris  
Pincès à iris  
Pinze per iride



**STEVENS 1:2**  
AB 718/01  
11,0 cm/4 1/2"



**STEVENS 1:2**  
AB 718/02  
11,0 cm/4 1/2"



**STEVENS**  
10,5 cm/4 1/2"



AB 720/01

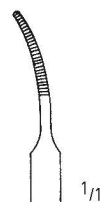

AB 720/02

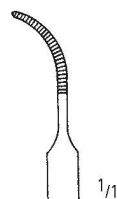

AB 720/03



AB 721/01 1:2

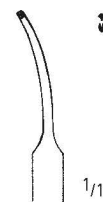

AB 721/02 1:2

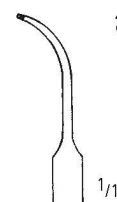

AB 721/03 1:2



**FISCHER-ARLT 1:2**  
AB 723/07  
7,0 cm/2 3/4"

AA

AB

AC

AD

AE

AK

AR

KA

KM

KO

KP

XR

**AB** PINZETTEN FORCEPS PINZAS PINCES PINZE

Irispinzetten  
Iris Forceps  
Pinzas para iris  
Pincès à iris  
Pinze per iride



**FOERSTER**  
AB 726/08  
8,5 cm/3 1/2"



**FOERSTER**  
AB 727/08  
8,5 cm/3 1/2"



**FOERSTER 1:2**  
AB 728/08  
8,5 cm/3 1/2"



**FOERSTER 1:2**  
AB 729/08  
8,5 cm/3 1/2"



**HESS 1:2**  
AB 730/07  
7,0 cm/2 3/4"



**HESS 1:2**  
AB 731/09  
9,0 cm/3 1/2"



**MOD. BONN 1:2**  
AB 734/01  
7,0 cm/2 3/4"

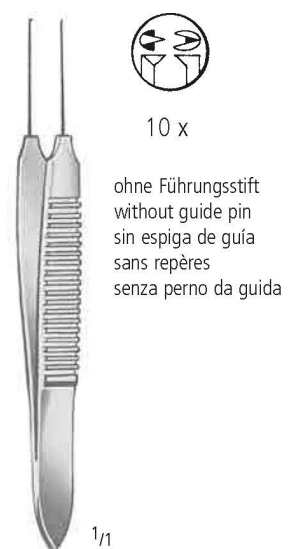

**MOD. BONN 1:2**  
AB 734/02  
7,0 cm/2 3/4"



PINZETTEN FORCEPS PINZAS PINCES PINZE

Irispinzetten  
Iris Forceps  
Pinzas para iris  
Pincas à iris  
Pinze per iride

AA

AB

AC

AD

AE

AK

AR

KA

KM

KO

KP

XR



**MOD. BONN**  
7,0 cm/2¾"

AB 735/01

AB 735/02

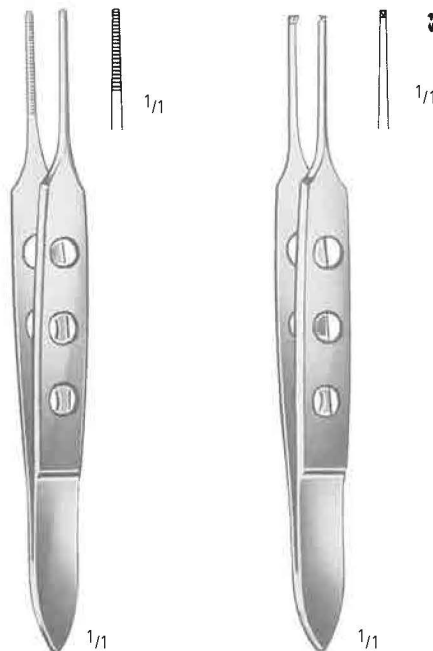

**BISHOP-HARMON**  
8,5 cm/3½"

AB 736/08

AB 738/08

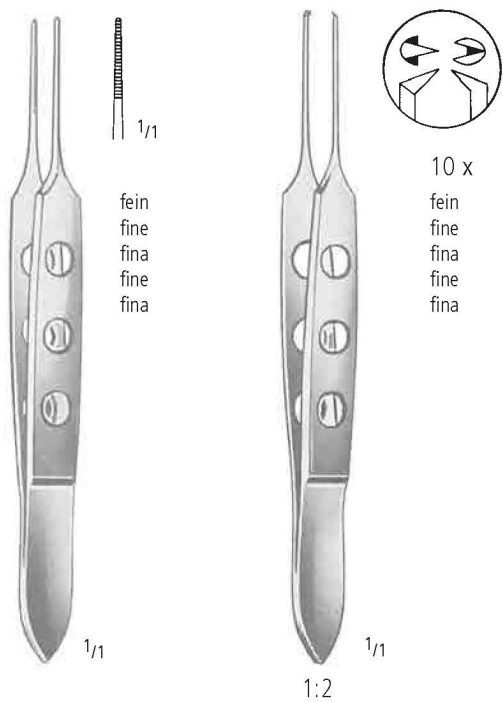

**BISHOP-HARMON**  
8,5 cm/3½"

AB 740/08

AB 742/08

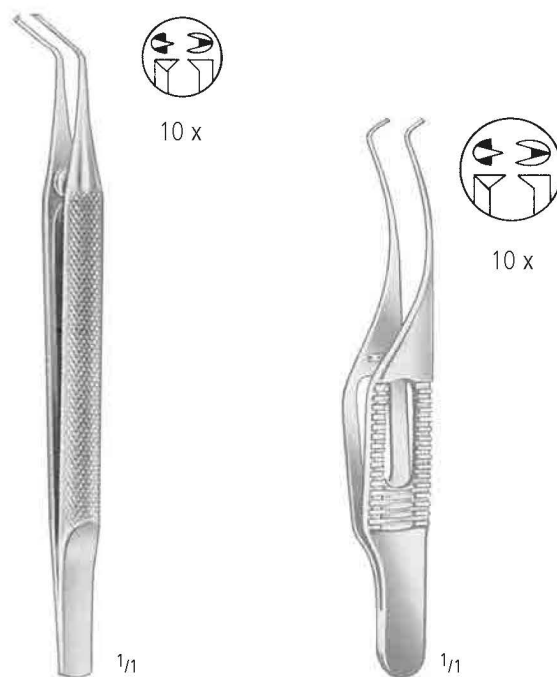

**KIRBY** 1:2  
AB 748/09  
9,0 cm/3½"

**BARRAQUER-KATZIN** 1:2  
(Colibri)  
AB 750/07  
7,0 cm/2¾"

**AB** PINZETTEN FORCEPS PINZAS PINCES PINZE

Irispinzetten, Kapselpinzetten  
 Iris Forceps, Capsular Forceps  
 Pinzas para iris, Pinzas capsulares  
 Pincès à iris, Pincès capsulaires  
 Pinze per iride, Pinze capsulari



10 x

**TROUTMAN 1:2**  
**(Corneal)**  
 AB 751/07  
 7,5 cm/3"



10 x

**BARRAQUER-KATZIN 1:2**  
**(Colibri)**  
 AB 752/07  
 7,0 cm/2<sup>3</sup>/<sub>4</sub>"

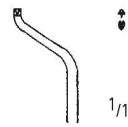

AB 756/07

Zähne seitwärts  
 teeth on side  
 dientes laterales  
 dents latérales  
 denti laterali



AB 757/07

Zähne unten  
 teeth below  
 dientes inferiores  
 dents en bas  
 denti in basso

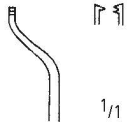

1/1

**GILL-HESS 1:2**  
 7,5 cm/3"



10 x

0,3 mm

**GILL 1:2**  
 AB 762/07  
 7,5 cm/3"



**GILL-FUCHS**  
 AB 763/07  
 7,5 cm/3"



**TERSON**  
 AB 765/09  
 9,0 cm/3<sup>1</sup>/<sub>2</sub>"



**CASTROVIEJO**  
 AB 767/01  
 10,0 cm/4"



**CASTROVIEJO**  
 AB 767/02  
 10,0 cm/4"

PINZETTEN FORCEPS PINZAS PINCES PINZE

Kapselpinzetten, Fixierpinzetten  
 Capsular Forceps, Fixation Forceps  
 Pinzas capsulares, Pinzas de fijación  
 Pincas capsulaires, Pincas à fixer  
 Pinze capsulari, Pinze fissatrici

AA

AB

AC

AD

AE

AK

AR

KA

KM

KO

KP

XR

ungeeicht  
 not calibrated  
 no calibrada  
 non calibrée  
 non calibrata

AB 768/01



geeicht  
 calibrated  
 calibrada  
 calibrée  
 calibrata

AB 768/02

**ARRUGA**  
 10,0 cm/4"

ungeeicht  
 not calibrated  
 no calibrada  
 non calibrée  
 non calibrata

AB 769/01



geeicht  
 calibrated  
 calibrada  
 calibrée  
 calibrata

AB 769/02

**ARRUGA**  
 10,0 cm/4"

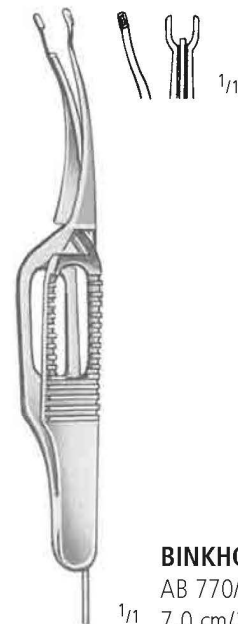

**BINKHORST**  
 AB 770/07  
 7,0 cm/2¾"



AB 785/01

ohne Schloss  
 without spring catch  
 sin cierre de resorte  
 sans arrêt à ressort  
 senza arresto a molla

AB 785/02

mit Schloss  
 with spring catch  
 con cierre de resorte  
 avec arrêt à ressort  
 con arresto a molla

**GRAEFE**  
 11,0 cm/4½"



AB 786/01  
 5 mm

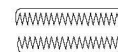

AB 786/02  
 10 mm



**GREEN**  
 10,0 cm/4"

**AB** PINZETTEN FORCEPS PINZAS PINCES PINZE

Fixierpinzetten, Nahtpinzetten  
 Fixation Forceps, Suture Forceps  
 Pinzas de fijación, Pinzas para sutura  
 Pinces à fixer, Pinces pour sutures  
 Pinze fissatrici, Pinze per sutura

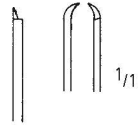

AB 790/09

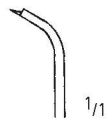

AB 791/09

**CASTROVIEJO 1:1**  
 1/1 9,0 cm/3 1/2"

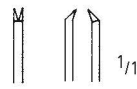

**ELSCHNIG 1:2**  
 AB 792/11  
 1/1 11,0 cm/4 1/2"

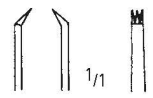

**ELSCHNIG 2:3**  
 AB 793/11  
 1/1 11,0 cm/4 1/2"

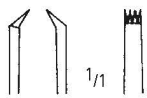

**ELSCHNIG 3:4**  
 AB 794/11  
 1/1 11,0 cm/4 1/2"



1:2  
 AB 796/02



2:3  
 AB 796/03

**LESTER**  
 1/1 9,0 cm/3 1/2"



**MOORFIELD**  
 AB 798/10  
 1/1 10,0 cm/4"

PINZETTEN FORCEPS PINZAS PINCES PINZE

Nahtpinzetten  
Suture Forceps  
Pinzas para sutura  
Pincas pour sutures  
Pinze per sutura

AA

AB

AC

AD

AE

AK

AR

KA

KM

KO

KP

XR

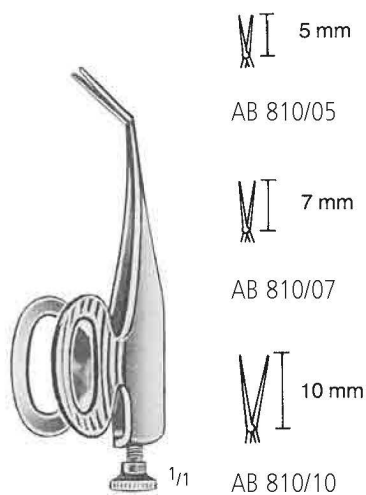

5 mm

AB 810/05

7 mm

AB 810/07

10 mm

AB 810/10

**BARRAQUER**  
5,5 cm/2<sup>1</sup>/<sub>4</sub>"

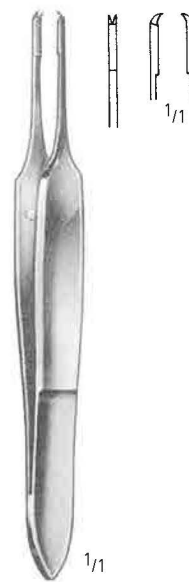

**ST. MARTIN 1:2**  
AB 812/07  
7,0 cm/2<sup>3</sup>/<sub>4</sub>"

Vorderkammer-Pinzetten  
Anterior Chamber Forceps  
Pinzas para la cámara anterior  
Pincas pour la chambre antérieure  
Pinze per la camera anteriore



AB 816/01

0,12 mm  
0,30 mm  
0,50 mm  
1,00 mm  
1,50 mm

AB 816/01  
AB 816/03  
AB 816/05  
AB 816/10  
AB 816/15

**CASTROVIEJO 1:2**  
10,0 cm/4"



AB 817/01

AB 817/01  
AB 817/03  
AB 817/05  
AB 817/10  
AB 817/15

**CASTROVIEJO 1:2**  
10,0 cm/4"



AB 819/01

AB 819/02

**McPHERSON**  
10,0 cm/4"



**AB** PINZETTEN FORCEPS PINZAS PINCES PINZE

Nahtpinzetten  
Suture Forceps  
Pinzas para sutura  
Pinces pour sutures  
Pinze per sutura

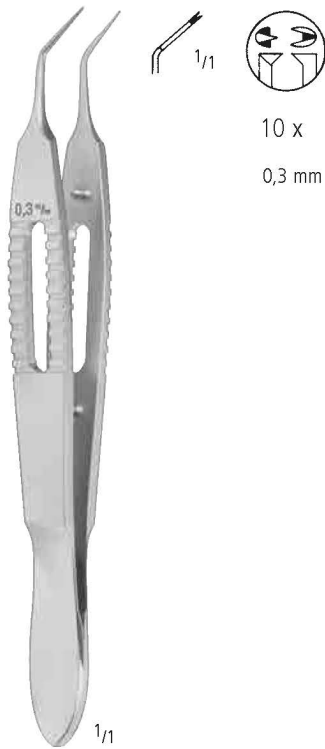

**KELMAN-McPHERSON 1:2**  
AB 820/10  
10,0 cm/4"



**BONACCOLTO**  
AB 824/01  
10,0 cm/4"



**BONACCOLTO**  
AB 824/02  
10,0 cm/4"

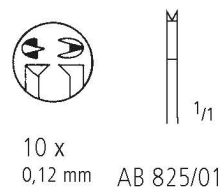

**MOD. BONN**  
10,0 cm/4"

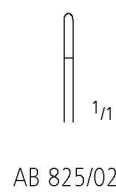

**MOD. TUBINGEN**  
AB 826/10  
10,0 cm/4"

PINZETTEN FORCEPS PINZAS PINCES PINZE

Nahtpinzetten, Fadenpinzetten  
 Suture Forceps, Suture Tying Forceps  
 Pinzas para sutura, Pinzas de ligadura  
 Pincers pour sutures, Pincers à ligature  
 Pinze per sutura, Pinze per ligature



**PAUFIQUE 1:2**  
 AB 828/10  
 10,0 cm/4"



**HARMS**  
 AB 829/01  
 10,0 cm/4"



**HARMS**  
 AB 829/02  
 10,0 cm/4"

AA

AB

AC

AD

AE

AK

AR

KA

KM

KO

KP

XR

**AB** PINZETTEN FORCEPS PINZAS PINCES PINZE

Muskelpinzetten  
Muscular Forceps  
Pinzas musculares  
Pincas musculaires  
Pinze muscolari

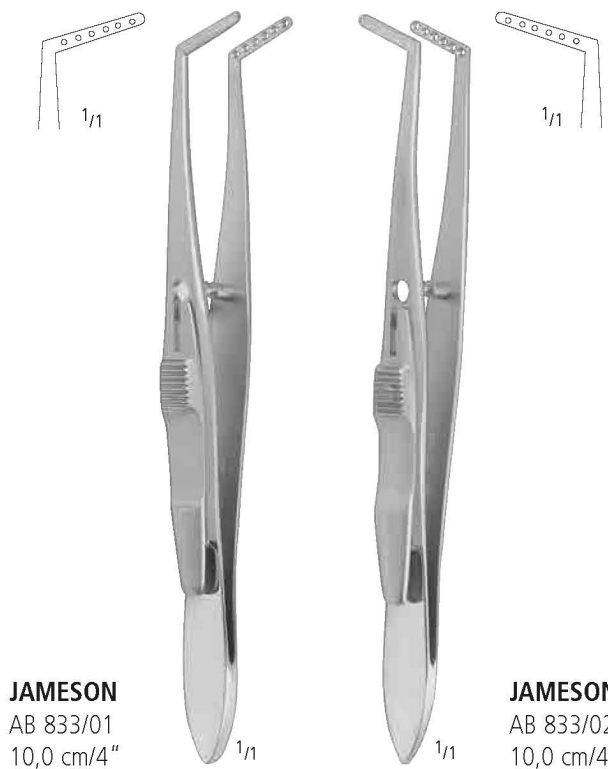
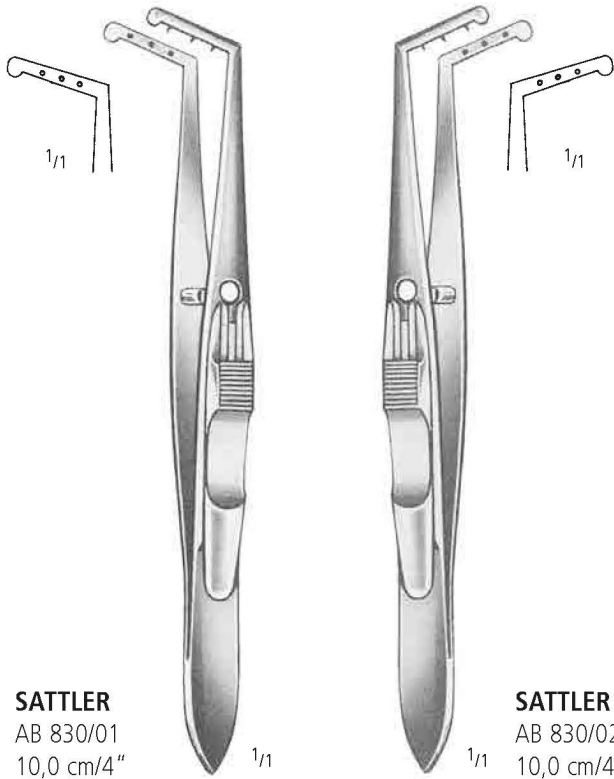

PINZETTEN FORCEPS PINZAS PINCES PINZE

Muskelpinzetten, Entropium- und Chalazionpinzetten  
 Muscular Forceps, Entropium and Chalazion Forceps  
 Pinzas musculares, Pinzas de entropión y de chalazión  
 Pincas musculaires, Pincas à entropion et à chalazion  
 Pinze muscolari, Pinze per palpebre (entropio) e per calazio



**BERENS**  
 AB 835/09  
 8,5 cm/3 1/2"



**ERHARDT**  
 AB 836/09  
 9,0 cm/3 1/2"



**SNELLEN**  
 AB 837/01  
 10,0 cm/4"



**SNELLEN**  
 AB 837/02  
 10,0 cm/4"



**AYER**  
 AB 838/01  
 9,0 cm/3 1/2"



**AYER**  
 AB 838/02  
 9,0 cm/3 1/2"

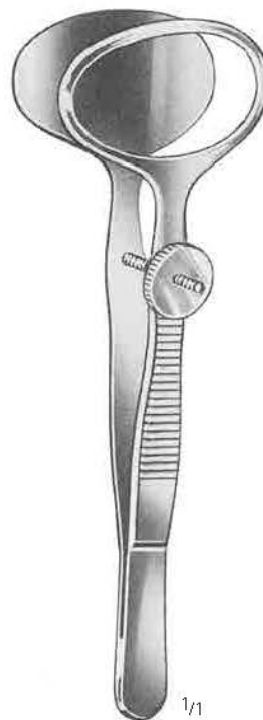

**DESMARRES**  
 9,0 cm/3 1/2"

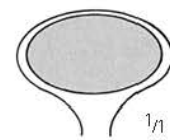

AB 840/01

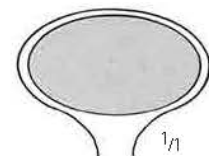

AB 840/02

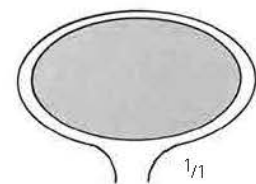

AB 840/03

AA

AB

AC

AD

AE

AK

AR

KA

KM

KO

KP

XR

**AB** PINZETTEN FORCEPS PINZAS PINCES PINZE

Chalazionpinzetten, Ptosispinzetten  
 Chalazion Forceps, Ptosis Forceps  
 Pinzas de chalazión, Pinzas para ptosis  
 Pincès à chalazion, Pincès à ptosis  
 Pinze per calazio, Pinze per ptosis



**LAMBERT**  
 AB 841/01  
 9,0 cm/3 1/2"

1/1



**LAMBERT**  
 AB 841/02  
 9,0 cm/3 1/2"

1/1



**BERKE**  
 AB 844/20  
 11,0 cm/4 1/2"  
 20 mm

1/1



**BERKE**  
 AB 844/27  
 11,0 cm/4 1/2"  
 27 mm

1/1



PINZETTEN FORCEPS PINZAS PINCES PINZE

Linsenhalte- und Kapsulorhexispinzetten  
 Lens Holding and Capsulorhexis Forceps  
 Pinzas para tener cristalino y capsulorhexis  
 Pincas à tenir de cristallins et capsulorhexis  
 Pinze per tenere il cristallino, Pinze capsulorhexis

AA

AB

AC

AD

AE

AK

AR

KA

KM

KO

KP

XR



**FAULKNER**  
 AB 848/11  
 11,0 cm/4 1/2"



AB 852/01  
 10,0 cm/4"



**McDONALD**  
 AB 852/02  
 10,0 cm/4"



SCHEREN  
SCISSORS  
TIJERAS  
CISEAUX  
FORBICI

AC

nopa<sup>®</sup> instruments

Weitere Scheren finden Sie in unserem Katalog „Allgemeines Instrumentarium“ in Gruppe AC.

For further scissors kindly refer to our catalogue „General Instruments“, section AC.

Para tijeras adicionales, por favor consulte nuestro catálogo de „Instrumental de uso general“, grupo AC.

Pour des ciseaux supplémentaires, consultez notre catalogue „Instrumentation Generale“, section AC.

Per gli altri forbici, consultare il nostro catalogo „Strumentazione Generale“, gruppo AC.





SCHEREN SCISSORS TIJERAS CISEAUX FORBICI

Feine Scheren, Augenscheren  
 Fine Scissors, Eye Scissors  
 Tijeras finas, Tijeras oculares  
 Ciseaux fins, Ciseaux oculaires  
 Forbici fini, Forbici oftalmologici

AA

AB

AC

AD

AE

AK

AR

KA

KM

KO

KP

XR

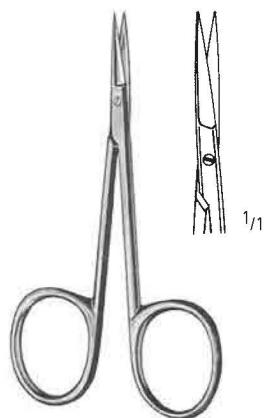

AC 430/08  
 8,0 cm/3 1/4"

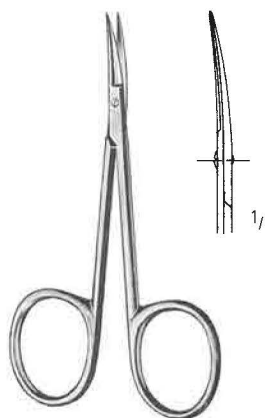

MOD. BONN  
 AC 431/08  
 8,0 cm/3 1/4"



11,5 cm/4 1/2"

Fig. 1

gerade  
 straight  
 rectas  
 droits  
 rette

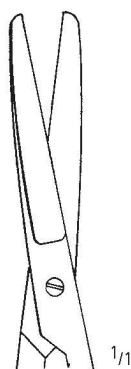

AC 446/01

Fig. 2

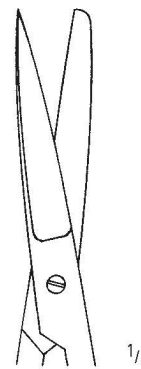

AC 446/02

Fig. 1

gebogen  
 curved  
 curvas  
 courbes  
 curve

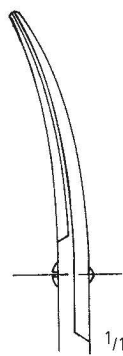

AC 447/01

Fig. 2

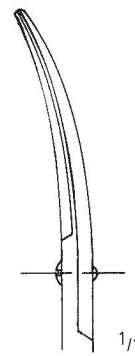

AC 447/02



AC SCHEREN SCISSORS TIJERAS CISEAUX FORBICI

Augenscheren  
Eye Scissors  
Tijeras oculares  
Ciseaux oculaires  
Forbici oftalmologici



AC 448/11  
11,5 cm/4 1/2"



AC 449/11  
11,5 cm/4 1/2"

Irisscheren  
Iris Scissors  
Tijeras para iridectomia  
Ciseaux à iridectomie  
Forbici per iridectomia

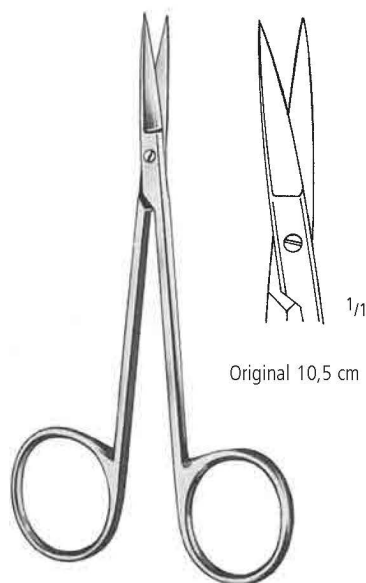

Original 10,5 cm

9,0 cm/3 1/2"  
10,5 cm/4 1/4"  
11,5 cm/4 1/2"

AC 450/09  
AC 450/10  
AC 450/11

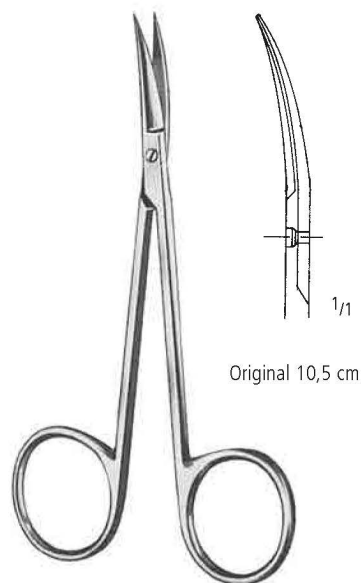

Original 10,5 cm

AC 451/09  
AC 451/10  
AC 451/11

SCHEREN SCISSORS TIJERAS CISEAUX FORBICI

Augenscheren  
Eye Scissors  
Tijeras oculares  
Ciseaux oculaires  
Forbici oftalmologici

AA

AB

AC

AD

AE

AK

AR

KA

KM

KO

KP

XR



Strabismusscheren  
Strabismus Scissors  
Tijeras para estrabismo  
Ciseaux à strabisme  
Forbici per strabismo

AC 460/11  
11,5 cm/4 1/2"

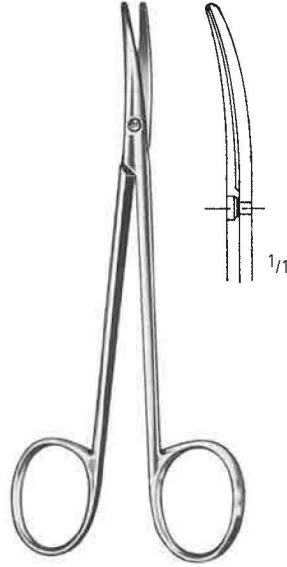

AC 461/11  
11,5 cm/4 1/2"

mit großen Ringen  
with large bows  
con anillos grandes  
avec grands anneaux  
con anelli grandi

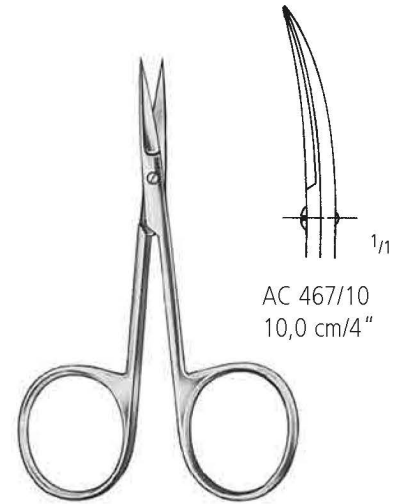

AC 467/10  
10,0 cm/4"

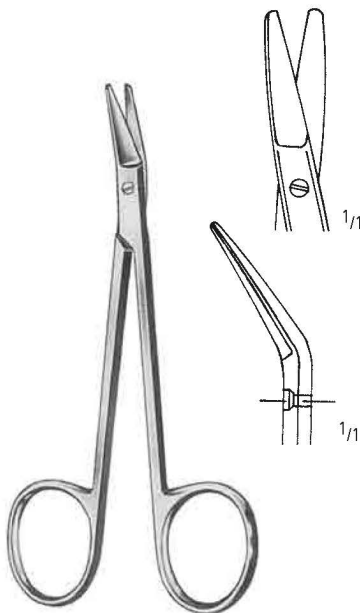

**GRAEFE**  
AC 469/10  
10,5 cm/4 1/4"

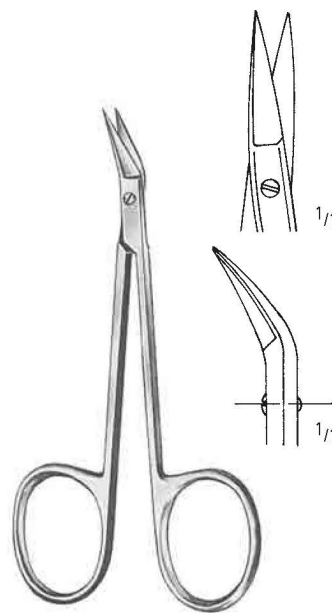

**WILMER**  
AC 471/10  
10,0 cm/4"

**AC** SCHEREN SCISSORS TIJERAS CISEAUX FORBICI

Augenscheren  
Eye Scissors  
Tijeras oculares  
Ciseaux oculaires  
Forbici oftalmologici

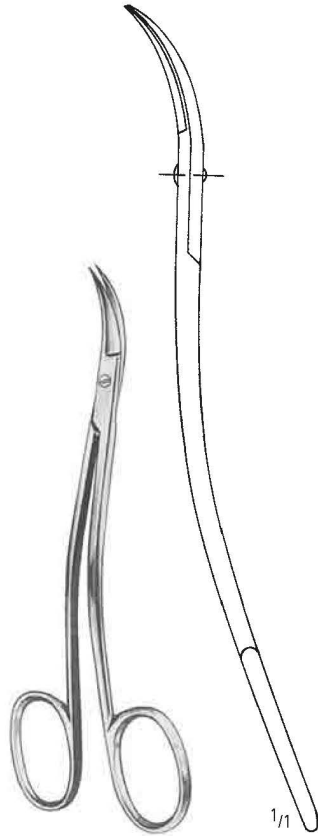

**LA GRANGE**  
AC 472/11  
11,5 cm/4<sup>1</sup>/<sub>2</sub>"

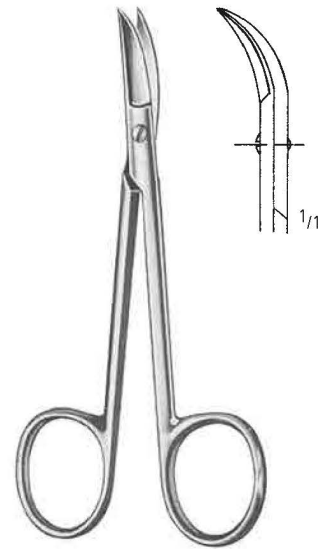

**CHADWICK**  
AC 473/11  
11,0 cm/4<sup>1</sup>/<sub>4</sub>"

Sehnenscheren  
Tenotomy Scissors  
Tijeras para tenotomía  
Ciseaux à ténatomie  
Forbici per tenotomia



**STEVENS**  
10,5 cm/4<sup>1</sup>/<sub>8</sub>"  
11,5 cm/4<sup>1</sup>/<sub>2</sub>"

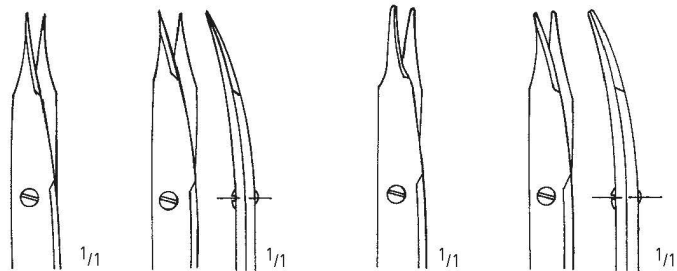

spitz  
agudas  
pointed  
pointues  
acuta

Original 11,5 cm

stumpf  
romas  
blunt  
mousses  
smussa

gerade  
straight  
rectas  
droits  
rette

gebogen  
curved  
curvas  
courbes  
curve

gerade  
straight  
rectas  
droits  
rette

gebogen  
curved  
curvas  
courbes  
curve

AC 474/10  
AC 474/11

AC 475/10  
AC 475/11

AC 476/10  
AC 476/11

AC 477/10  
AC 477/11

SCHEREN SCISSORS TIJERAS CISEAUX FORBICI

Augenscheren  
Eye Scissors  
Tijeras oculares  
Ciseaux oculaires  
Forbici oftalmologici

AA  
AB  
AC  
AD  
AE  
AK  
AR  
KA  
KM  
KO  
KP  
XR

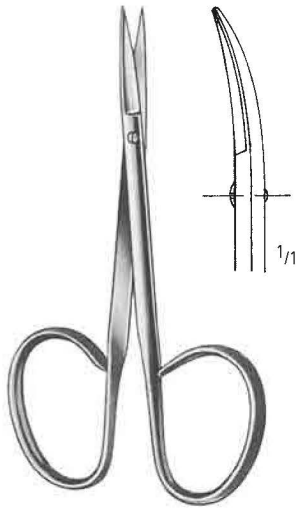

gerade  
straight  
rectas  
droits  
rette

gebogen  
curved  
curvas  
courbes  
curve

**RIBBON**  
10,0 cm/4"  
AC 488/10 AC 489/10

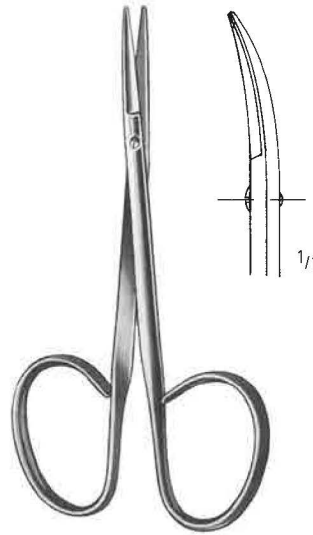

gerade  
straight  
rectas  
droits  
rette

gebogen  
curved  
curvas  
courbes  
curve

**RIBBON**  
10,0 cm/4"  
AC 490/10 AC 491/10

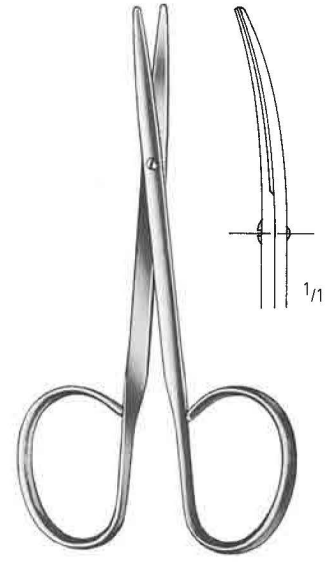

gerade  
straight  
rectas  
droits  
rette

gebogen  
curved  
curvas  
courbes  
curve

**RIBBON**  
10,0 cm/4"  
AC 492/10 AC 493/10

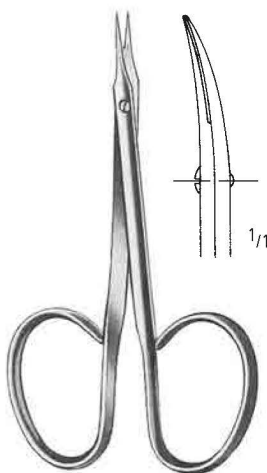

gerade  
straight  
rectas  
droits  
rette

gebogen  
curved  
curvas  
courbes  
curve

**RIBBON**  
9,5 cm/3<sup>3</sup>/<sub>4</sub>"  
AC 494/09 AC 495/09

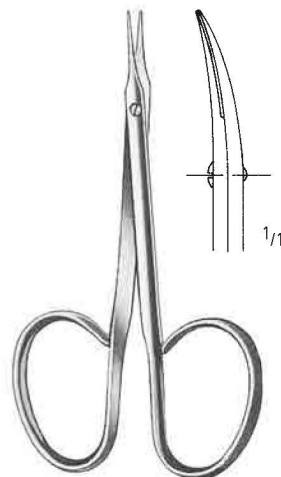

gerade  
straight  
rectas  
droits  
rette

gebogen  
curved  
curvas  
courbes  
curve

**RIBBON**  
9,5 cm/3<sup>3</sup>/<sub>4</sub>"  
AC 496/09 AC 497/09

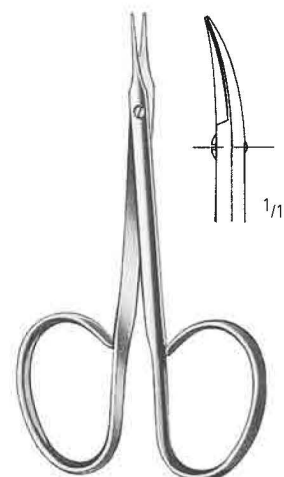

gerade  
straight  
rectas  
droits  
rette

gebogen  
curved  
curvas  
courbes  
curve

**RIBBON**  
9,5 cm/3<sup>3</sup>/<sub>4</sub>"  
AC 498/09 AC 499/09

**AC** SCHEREN SCISSORS TIJERAS CISEAUX FORBICI

Ligaturscheren, Iridektomiescheren  
 Ligature Scissors, Iris Scissors  
 Tijeras para ligaduras, Pinzas-tijeras para iridectomía  
 Ciseaux à ligatures, Ciseaux à iridectomie  
 Forbici per legatura, Forbici per iridectomia



**SPENCER**  
 9,5 cm/3 1/2" AC 500/09  
 10,5 cm/4 1/4" AC 500/10

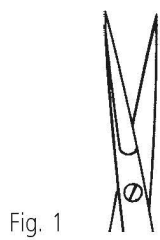
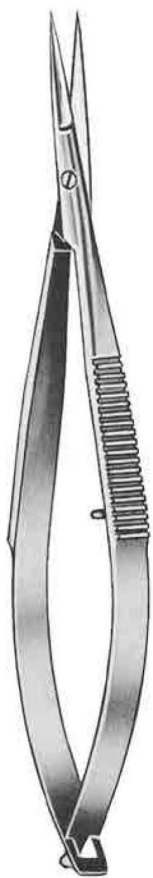

Fig. 1

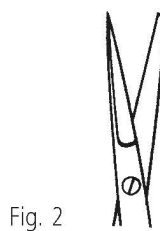

Fig. 2

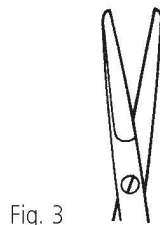
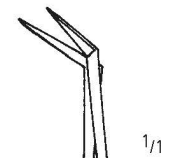
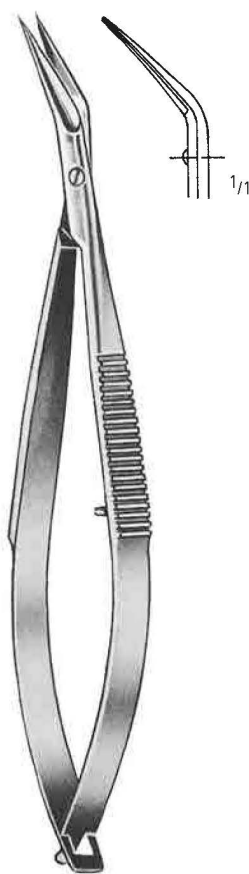

Fig. 3

**NOYES**  
 12,0 cm/4 3/4"

Fig.1 AC 750/12  
 Fig. 2 AC 752/12  
 Fig. 3 AC 754/12



AC 760/11

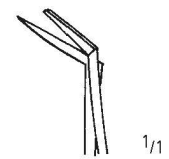

AC 762/11

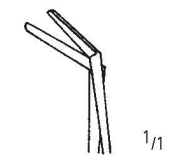

AC 764/11

**WECKER**  
 11,0 cm/4 1/2"

AC 751/12  
 AC 753/12  
 AC 755/12

SCHEREN SCISSORS TIJERAS CISEAUX FORBICI

Iridektomiescheren  
 Iris Scissors  
 Pinzas-tijeras para iridectomía  
 Ciseaux à iridectomie  
 Forbici per iridectomia

AA

AB

AC

AD

AE

AK

AR

KA

KM

KO

KP

XR



**BARRAQUER**  
 5,5 cm/2 1/4"

- 5 mm AC 768/05
- 7 mm AC 768/07
- 10 mm AC 768/10



**CASTROVIEJO**  
 AC 770/00  
 9,0 cm/3 1/2"



AC 770/02

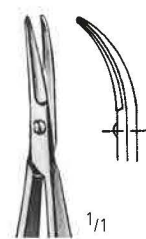

AC 770/03



AC 771/09



AC 772/09

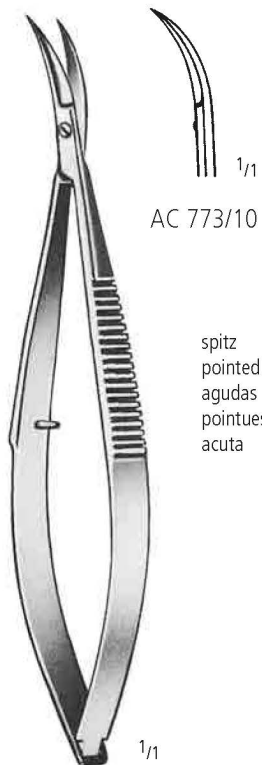

AC 773/10

spitz  
 pointed  
 agudas  
 pointues  
 acuta

**CASTROVIEJO**  
 10,0 cm/4"

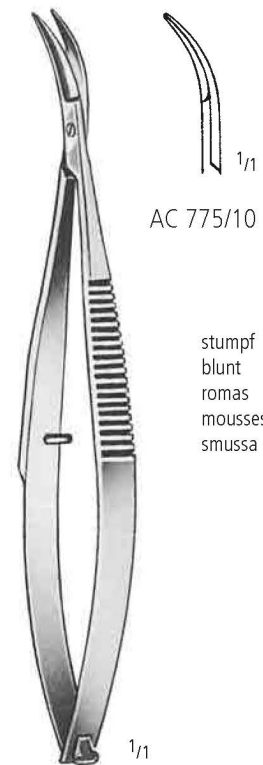

AC 775/10

stumpf  
 blunt  
 romas  
 mouses  
 smussa

**CASTROVIEJO**  
 10,0 cm/4"



**AC** SCHEREN SCISSORS TIJERAS CISEAUX FORBICI

Nachstarscheren  
 Secondary Cataract Scissors  
 Pinzas-tijeras para catarata secundaria  
 Pincis ciseaux pour le cataracte secondaire  
 Pinze-forbici per cataratta secundaria

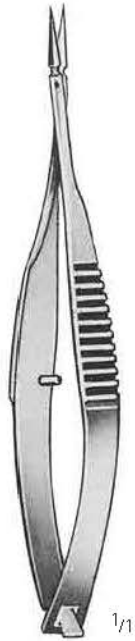

gerade  
 straight  
 rectas  
 droits  
 rette

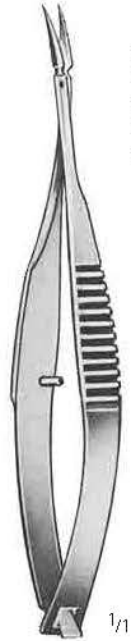

gebogen  
 curved  
 curvas  
 courbes  
 curve

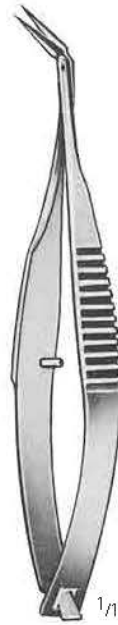

kniegebogen  
 angular  
 acodadas  
 coudés  
 angolato

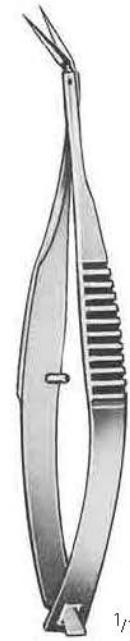

aufgewinkelt  
 angled on flat  
 acodadas hacia arriba  
 coudés vers le haut  
 angolato in alto

**VANNAS MOD. TÜBINGEN**

AC 776/01  
 8,5 cm/3 1/2"

AC 776/02  
 8,5 cm/3 1/2"

AC 776/03  
 8,5 cm/3 1/2"

AC 776/04  
 8,5 cm/3 1/2"

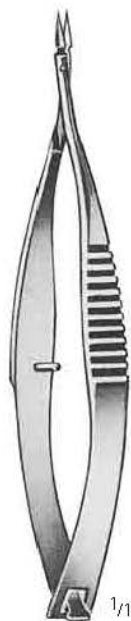

gerade  
 straight  
 rectas  
 droits  
 rette

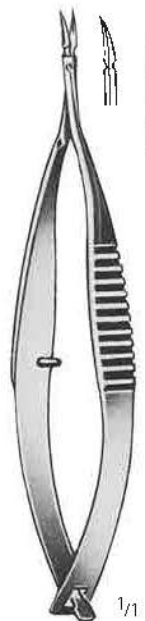

gebogen  
 curved  
 curvas  
 courbes  
 curve

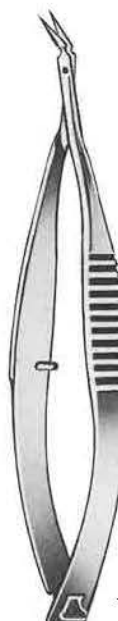

kniegebogen  
 angular  
 acodadas  
 coudés  
 angolato

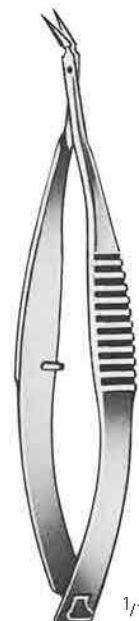

aufgewinkelt  
 angled on flat  
 acodadas hacia arriba  
 coudés vers le haut  
 angolato in alto

**VANNAS**  
 AC 778/01  
 8,0 cm/3 1/4"

**VANNAS**  
 AC 778/02  
 8,0 cm/3 1/4"

**VANNAS**  
 AC 778/03  
 8,0 cm/3 1/4"

**VANNAS**  
 AC 778/04  
 8,0 cm/3 1/4"

SCHEREN SCISSORS TIJERAS CISEAUX FORBICI

Nachstarscheren, Sehnenscheren, Hornhautscheren  
 Secondary Cataract Scissors, Tenotomy Scissors, Corneal Scissors  
 Pinzas-tijeras para catarata secundaria, Pinzas-tijeras para tenotomía y córnea  
 Pincas ciseaux pour le cataracte secondaire, Ciseaux à ténatomie, Ciseaux corneales  
 Pinze-forbici per cataratta secondaria, Forbici per tenotomia e per cornea

AA

AB

AC

AD

AE

AK

AR

KA

KM

KO

KP

XR



**GILLS-WELSH**  
 8,5 cm/3 1/2"



AC 779/01



AC 779/02



AC 779/03

kniegebogen  
 angular  
 acodadas  
 coudés  
 angolato



AC 779/04

aufgewinkelt  
 angled on flat  
 acodadas hacia arriba  
 coudés vers le haut  
 angolato in alto



**WESTCOTT**  
 AC 780/11  
 11,0 cm/4 1/2"

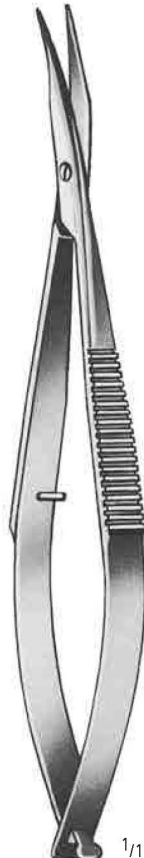

**WESTCOTT**  
 AC 782/11  
 11,0 cm/4 1/2"



**CASTROVIEJO**  
 AC 785/01  
 10,0 cm/4"



**CASTROVIEJO**  
 AC 785/02  
 10,0 cm/4"

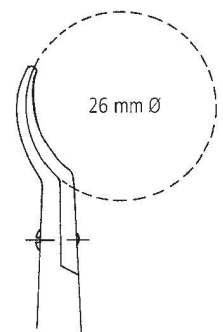

**AC** SCHEREN SCISSORS TIJERAS CISEAUX FORBICI

Hornhautscheren  
 Corneal Scissors  
 Pinzas-tijeras para córnea  
 Ciseaux corneales  
 Forbici per cornea

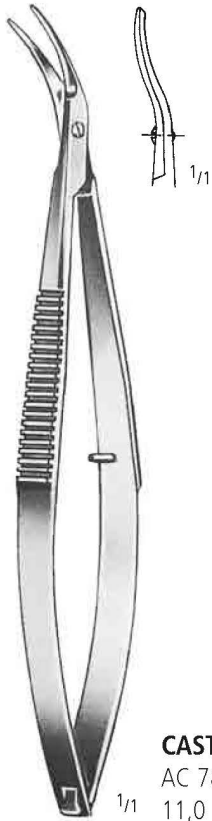

**CASTROVIEJO**  
 AC 786/01  
 11,0 cm/4 1/2"

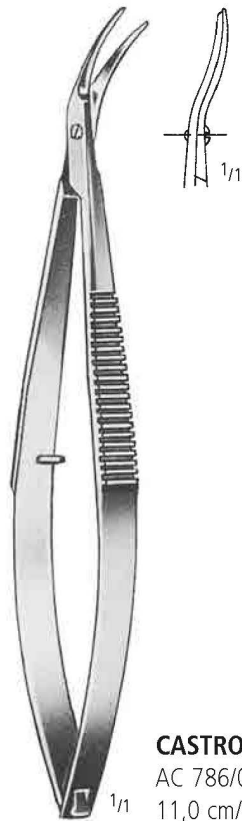

**CASTROVIEJO**  
 AC 786/02  
 11,0 cm/4 1/2"



**TROUTMAN**  
 AC 788/01  
 10,0 cm/4"



**TROUTMAN**  
 AC 788/02  
 10,0 cm/4"



**KATZIN**  
 AC 790/01  
 10,0 cm/4"

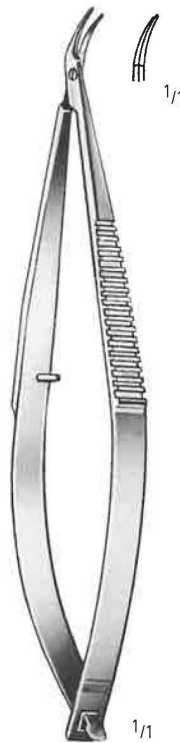

**KATZIN**  
 AC 790/02  
 10,0 cm/4"

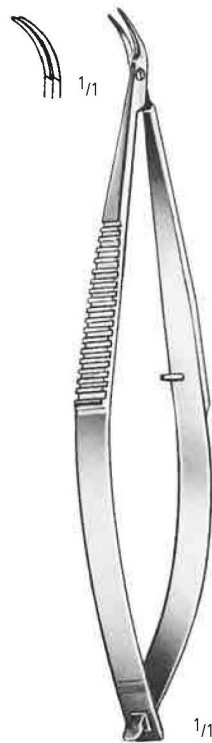

**KATZIN**  
 AC 791/01  
 11,0 cm/4 1/2"

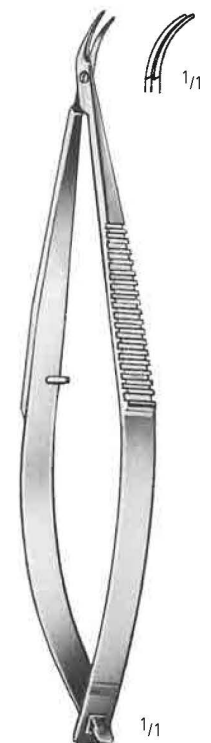

**KATZIN**  
 AC 791/02  
 11,0 cm/4 1/2"

SCHEREN SCISSORS TIJERAS CISEAUX FORBICI

Hornhautscheren  
 Corneal Scissors  
 Pinzas-tijeras para córnea  
 Ciseaux corneales  
 Forbici per cornea

AA

AB

AC

AD

AE

AK

AR

KA

KM

KO

KP

XR

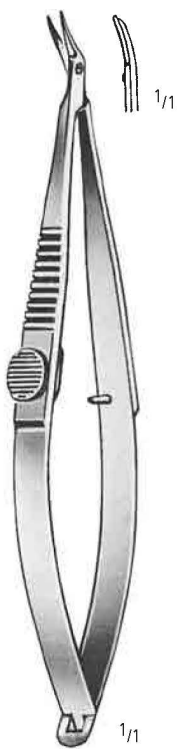

**KATZIN-BARRAQUER**

AC  
 792/01  
 10,0 cm/4"

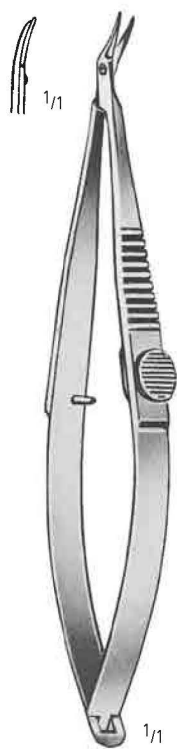

AC 792/02  
 10,0 cm/4"

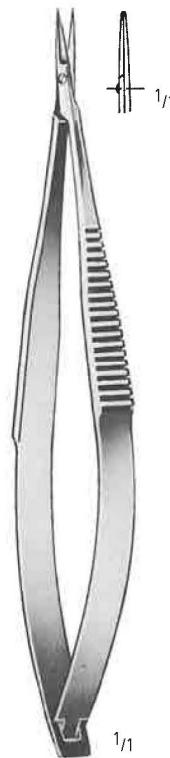

AC 793/00  
 10,0 cm/4"

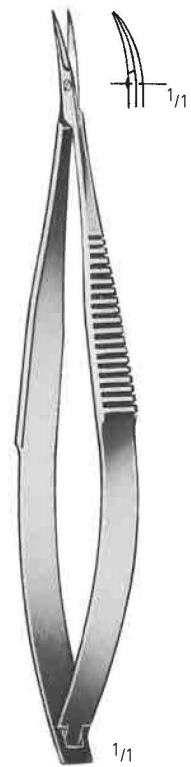

AC 793/01  
 10,0 cm/4"

Hornhautscheren, Mikroscheren  
 Corneal Section Scissors, Micro Scissors  
 Pinzas-tijeras para córnea, Micro Tijeras  
 Pincis ciseaux corneales, Micro-ciseaux  
 Forbici per cornea, Micro forbici



AC 794/12  
 12,0 cm/4<sup>3</sup>/<sub>4</sub>"



**NOYES**  
 AC 795/15  
 15,0 cm/6"



**WESTCOTT**  
 AC 797/01  
 11,5 cm/4<sup>1</sup>/<sub>2</sub>"



**WESTCOTT**  
 AC 797/02  
 11,5 cm/4<sup>1</sup>/<sub>2</sub>"



SCHEREN SCISSORS TIJERAS CISEAUX FORBICI

Mikroscheren  
Micro Scissors  
Micro Tijeras  
Micro Ciseaux  
Micro Forbici

- >> Alle unsere Mikroscheren werden von Fachkräften mit jahrelanger Erfahrung hergestellt. Die Endkontrolle findet unter dem Mikroskop statt. Um Ihnen ein ermüdungsfreies Arbeiten zu ermöglichen, wird dem Federdruck größte Aufmerksamkeit gewidmet.
- >> Bitte wählen Sie unter Rund- oder Flachgriffscheren.

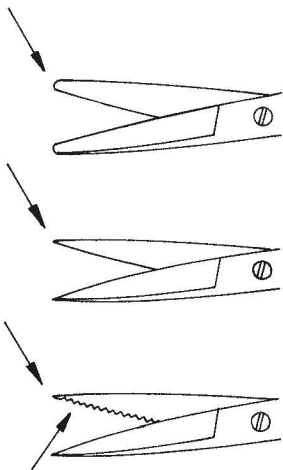

**Dissection:** **Gebogene Blätter, abgerundete Spitzen** ermöglichen eine gute und sichere Dissektion, ohne Nerven und Blutgefäße zu beschädigen.

**Adventitia:** **Gerade Blätter, sehr scharfe Spitzen** gewährleisten präzises Anfrischen von Gefäßenden.

**Nerve:** Ein Blatt ist **fein gezahnt**, um ein Herausgleiten des Nervs zu vermeiden.

- >> All our Micro Scissors are manufactured by skilled craftsmen with many years of experience. Final inspection is carried out under a microscope. Careful attention is paid to the closing pressure of the spring handle, to ensure precise work during surgeries, without fatigue.
- >> Round or flat handle scissors according to your preference.

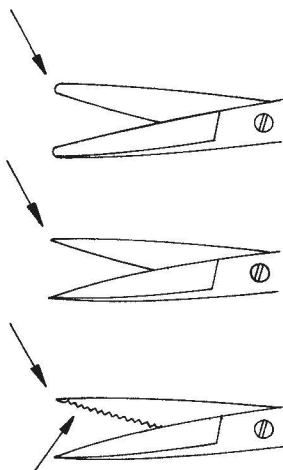

**Dissection:** **Curved blades, slightly rounded tips** ensure safe dissection without damage to nerves and vessels.

**Adventitia:** **Straight blades, very sharp tips** for finest trimming of vessel ends.

**Nerve:** One blade is **fine-toothed** to avoid slipping of the nerve.

AA

AB

AC

AD

AE

AK

AR

KA

KM

KO

KP

XR



**AC** SCHEREN SCISSORS TIJERAS CISEAUX FORBICI

Mikroscheren  
Micro Scissors  
Micro Tijeras  
Micro Ciseaux  
Micro Forbici



14,5 cm/5<sup>3</sup>/<sub>4</sub>"

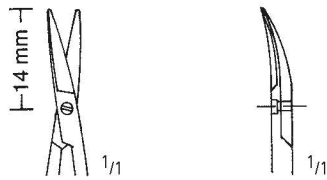

**Dissection**  
AC 801/15

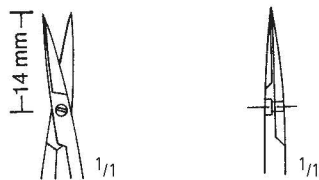

**Adventitia**  
AC 803/15



18,0 cm/7"

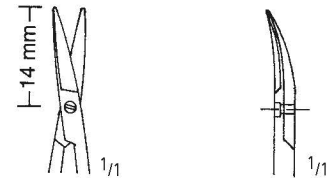

**Dissection**  
AC 801/18

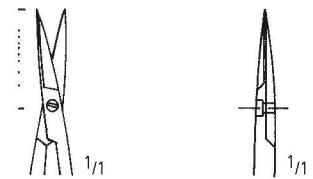

**Adventitia**  
AC 803/18

SCHEREN SCISSORS TIJERAS CISEAUX FORBICI

Mikroscheren  
Micro Scissors  
Micro Tijeras  
Micro Ciseaux  
Micro Forbici

AA

AB

AC

AD

AE

AK

AR

KA

KM

KO

KP

XR

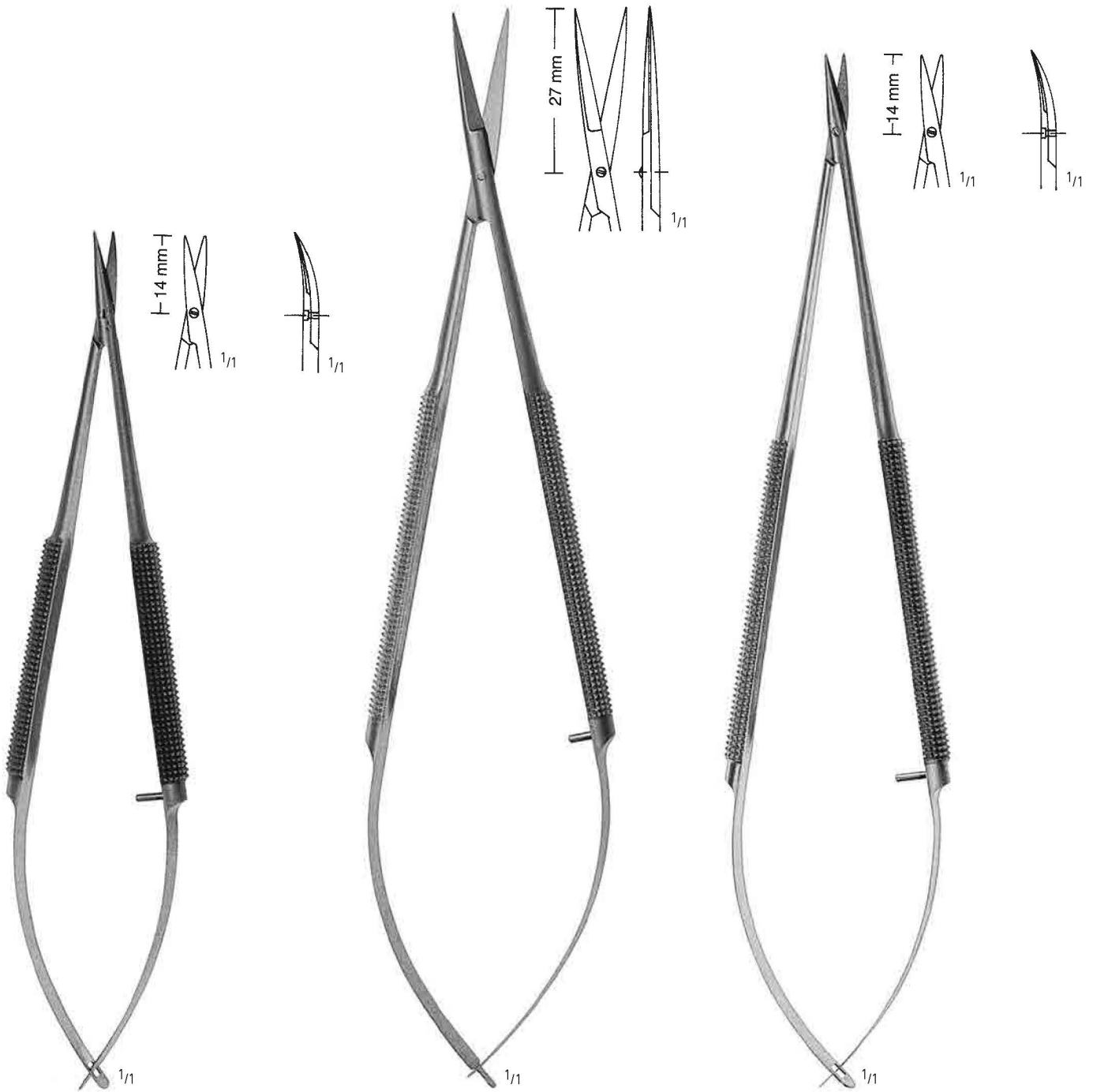

AC 807/14  
14,5 cm/5<sup>3</sup>/<sub>4</sub>"

AC 812/18  
18,0 cm/7"

AC 817/18  
18,0 cm/7"

**AC** SCHEREN SCISSORS TIJERAS CISEAUX FORBICI

Mikroscheren  
Micro Scissors  
Micro Tijeras  
Micro Ciseaux  
Micro Forbici



11,0 cm/4<sup>1</sup>/<sub>3</sub>"

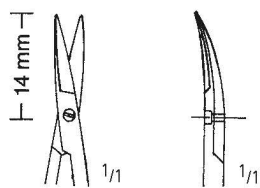

**Dissection**  
AC 821/11

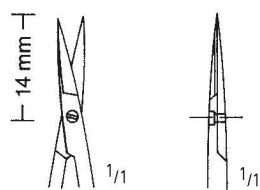

**Adventitia**  
AC 830/11



15,0 cm/6"

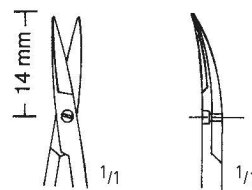

**Dissection**  
AC 823/15

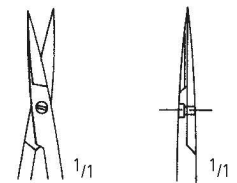

**Adventitia**  
AC 832/15

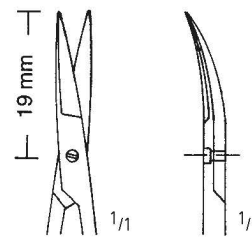

**Dissection**  
AC 825/15

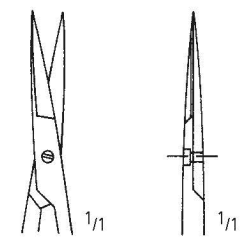

**Adventitia**  
AC 834/15

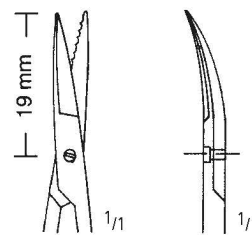

**Dissection**  
AC 827/15

>> Nerve >>

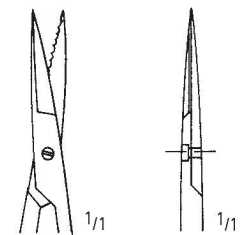

**Adventitia**  
AC 836/15

SCHEREN SCISSORS TIJERAS CISEAUX FORBICI

Mikroscheren  
Micro Scissors  
Micro Tijeras  
Micro Ciseaux  
Micro Forbici

AA

AB

AC

AD

AE

AK

AR

KA

KM

KO

KP

XR

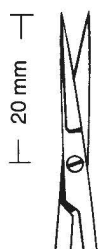
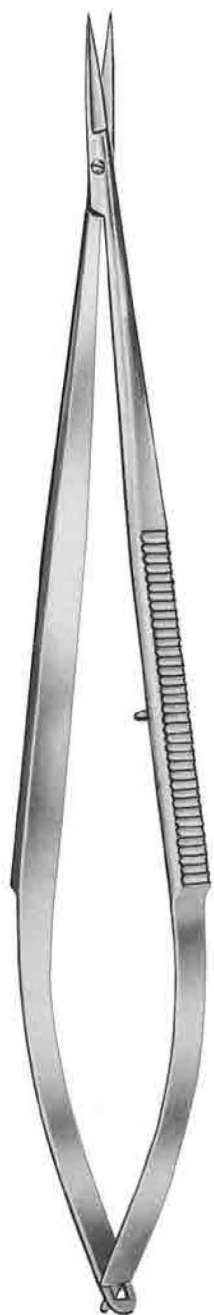

AC 850/19



AC 851/19

18,5 cm/7 1/3"



AC 860/16  
AC 860/20  
AC 860/22



AC 861/16  
AC 861/20  
AC 861/22



AC 862/16  
AC 862/20  
AC 862/22



AC 863/16  
AC 863/20  
AC 863/22



AC 864/16  
AC 864/20  
AC 864/22



AC 865/16  
AC 865/20  
AC 865/22

16,0 cm/6 1/4"  
20,0 cm/8"  
22,5 cm/9"

Mikroscheren  
Micro Scissors  
Micro Tijeras  
Micro Ciseaux  
Micro Forbici

# T = TITAN



18,0 cm/7"



AC 870/01  
AC 870/01 T  
25°

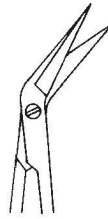

AC 870/02  
AC 870/02 T  
45°

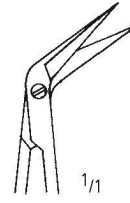

AC 870/03  
AC 870/03 T  
60°

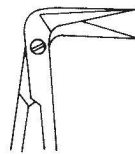

AC 870/04  
AC 870/04 T  
90°

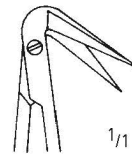

AC 870/05  
AC 870/05 T  
125°



18,0 cm/7"



18,0 cm/7"



AC 871/01  
AC 871/01 T  
25°



AC 871/02  
AC 871/02 T  
45°

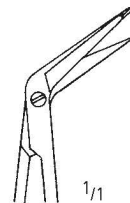

AC 871/03  
AC 871/0  
60°



AC 871/04  
AC 871/04 T  
90°

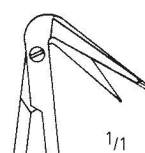

AC 871/05  
AC 871/05 T  
125°



18,0 cm/7"

SKALPELLE  
SCALPELS  
BISTURIES  
BISTOURIS  
BISTURI

AD

nopa<sup>®</sup> instruments

Weitere Skalpelle finden Sie in unserem Katalog „Allgemeines Instrumentarium“ in Gruppe AD.

For further scalpels kindly refer to our catalogue „General Instruments“, section AD.

Para bisturios adicionales, por favor consulte nuestro catálogo de „Instrumental de uso general“, grupo AD.

Pour des bistouris supplémentaires, consultez notre catalogue „Instrumentation Generale“, section AD.

Per gli altri bisturi, consultare il nostro catalogo „Strumentazione Generale“, gruppo AD.





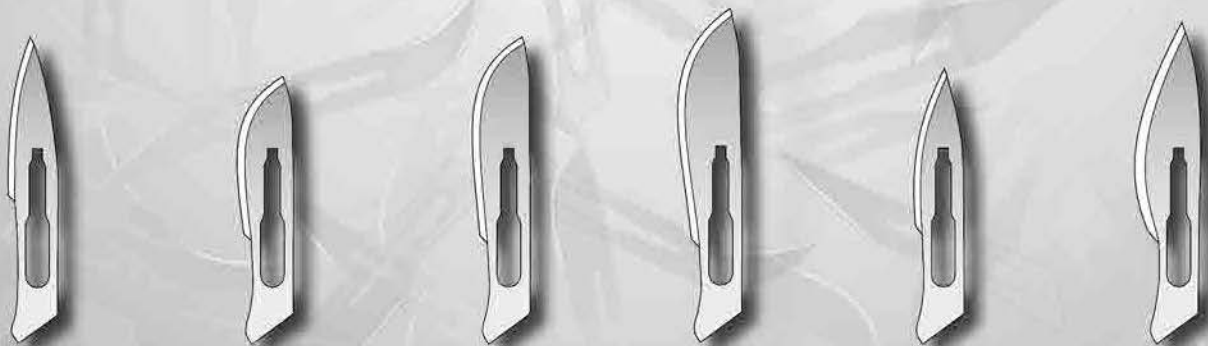
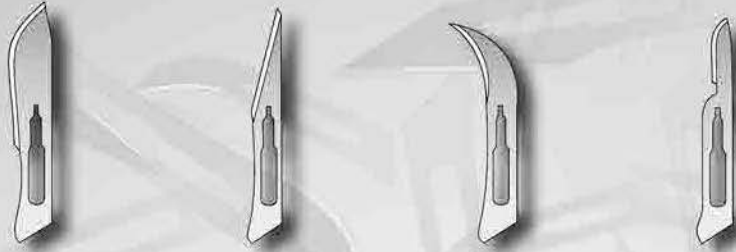

SKALPELLE SCALPELS BISTURIES BISTOURIS BISTURI

Skalpeligriffe  
 Scalpel Handles  
 Mangos de bisturías  
 Manches pour bistouris  
 Manici per bisturi

AA

AB

AC

AD

AE

AK

AR

KA

KM

KO

KP

XR

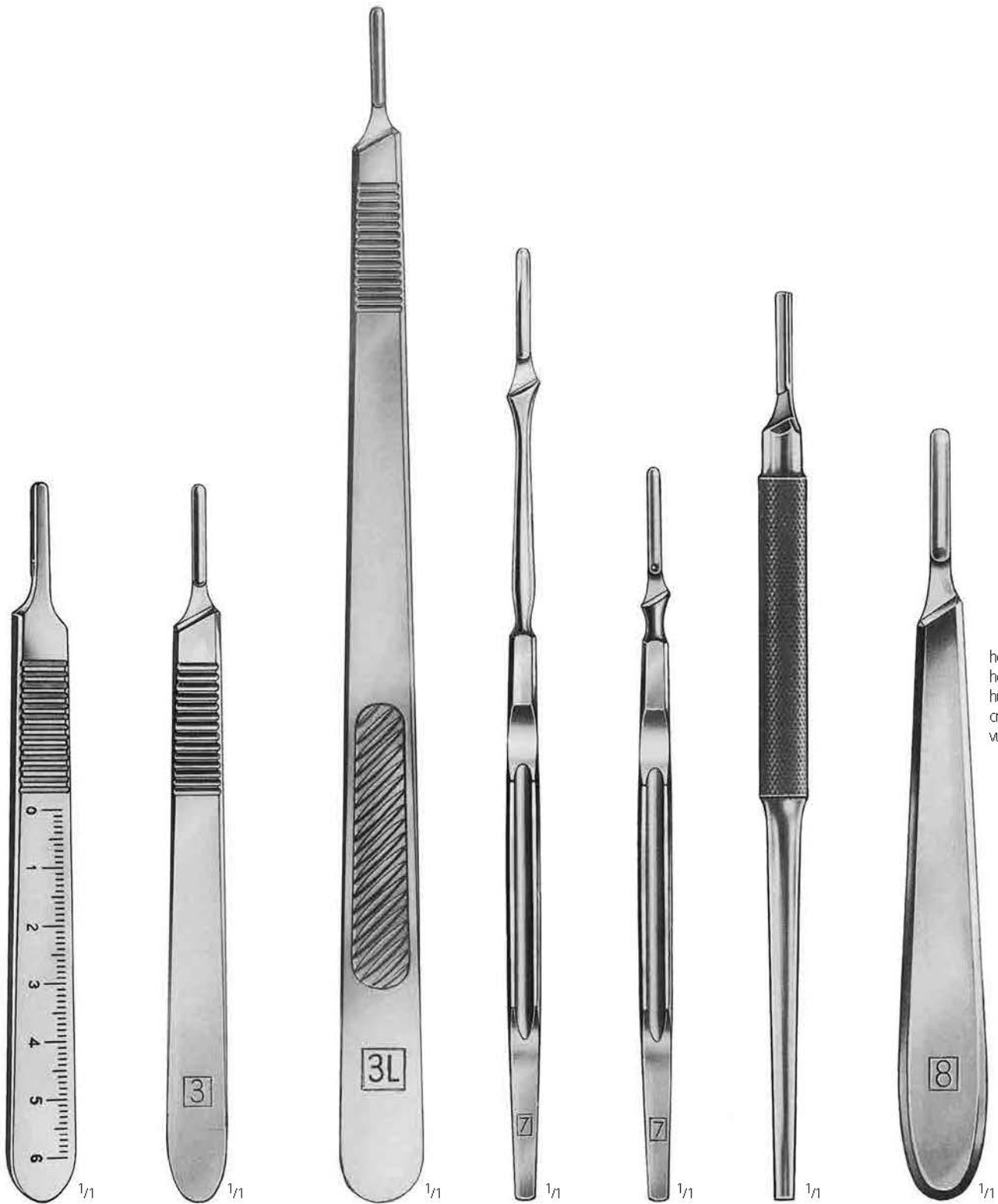

hohl  
 hollow  
 hueco  
 creux  
 vuoto

AD 009/03  
 No. 3

AD 010/03  
 No. 3

AD 020/13  
 No. 3L

AD 025/07  
 No. 7

AD 027/07  
 No. 7K

AD 030/16

**COLLIN**  
 AD 040/08  
 No. 8

Skalpelli, Skalpellgriffe, Skalpellklingen  
 Scalpel Handles, Scalpel Blades  
 Mangos de bisturías, Hojas de bisturías  
 Manches pour bistouris, Lames de bistouris  
 Manici per bisturi, Lame per bisturi

# MINI

Verpackungseinheit 10 St.  
 packing unit 10 pcs.  
 unidad de venta 10 piezas  
 unité à 10 pièce  
 unità di vendita 10 pezzi

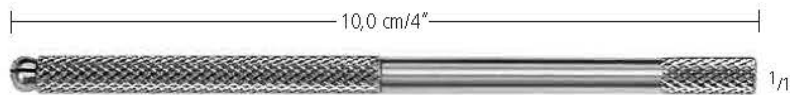

Fig. 65  
AD 065/65

steril  
 sterile  
 estériles  
 stériles  
 sterili



Fig. 67  
AD 065/67



AD 065/10

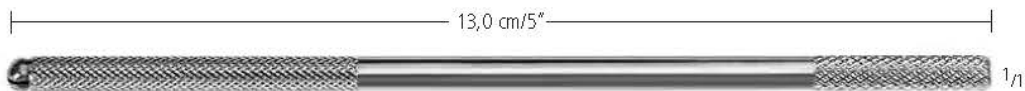

AD 065/13

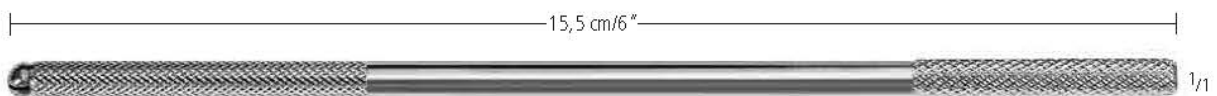

AD 065/15

SKALPELLE SCALPELS BISTURIES BISTOURIS BISTURI

Skalpellklingen  
 Scalpel Blades  
 Hojas de bisturíes  
 Lames pour bistouris  
 Lame per bisturi

passend für die Griffe  
 for handles  
 para los mangos  
 pour les manches  
 per i manici

- AD 009/03
- AD 010/03
- AD 020/13
- AD 025/07
- AD 027/07
- AD 030/16
- AD 040/08



Fig.10  
 AD 075/10



Fig.11  
 AD 075/11



Fig.15  
 AD 075/15



Fig.15c  
 AD 076/15

steril  
 sterile  
 estériles  
 stériles  
 sterili



AA

AB

AC

AD

AE

AK

AR

KA

KM

KO

KP

XR

**AD** SKALPELLE SCALPELS BISTURIES BISTOURIS BISTURI

Rasierklingen, Klingenbrecher  
 Razor Blades, Blade Breakers  
 Hojas de afeitár, Pinzas para romper hojas  
 Lames de rasoir, Pincettes pour casser les lames  
 Lamette da barba, Pinze per rompere la lamette

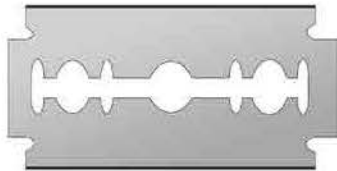

RASIERKLINGEN, VERPACKUNGSEINHEIT 10 STCK  
 RAZOR BLADES, PACKING UNIT 10 PIECES  
 HOJAS DE AFEITAR, UNIDAD DE VENTA 10 PZ  
 LAMES DE RASOIR, UNITÉ À 10 PIÈCES  
 LAMETTE DA BARBA, UNITÀ DI VENDITA 10 PZ

AD 540/00



**TROUTMAN-CHRIS**

AD 550/09  
 Ø 5,5 mm  
 9,0 cm/3<sup>1</sup>/<sub>2</sub>"



**TROUTMAN-CHRIS**

AD 551/09  
 Ø 5,5 mm  
 9,0 cm/3<sup>1</sup>/<sub>2</sub>"



AD 552/11  
 11,0 cm/4<sup>1</sup>/<sub>3</sub>"

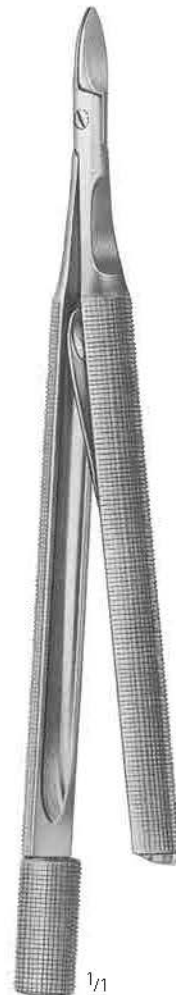

**CASTROVIEJO**

AD 554/13  
 Ø 8 mm  
 13,0 cm/5"



NAHT  
SUTURE  
SUTURA  
SUTURE  
SUTURA

AE

nopa<sup>®</sup> instruments

Weitere Naht-Instrumente finden Sie in unserem Katalog „Allgemeines Instrumentarium“ in Gruppe AE.

For further suture instruments kindly refer to our catalogue „General Instruments“, section AE.

Para instrumentos de sutura adicionales, por favor consulte nuestro catálogo de „Instrumental de uso general“, grupo AE.

Pour des instruments de suture supplémentaires, consultez notre catalogue „Instrumentation Generale“, section AE.

Per gli altri accessori di sutura, consultare il nostro catalogo „Strumentazione Generale“, gruppo AE.





Nadelhalter, Nadelhalter mit Hartmetalleinsätzen  
 Needle Holders, Needle Holders with Tungsten Carbide Inserts  
 Porta-agujas, Porta-agujas con bocas de carburo de Tungsteno  
 Porte-aiguilles, Porte-aiguilles à mors en carbure de tungstène  
 Portaghi, Portaghi con placche di carburo di tungsteno

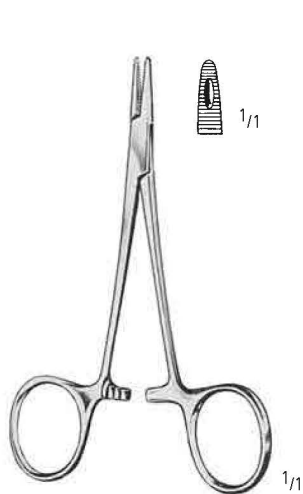

**DERF**  
 AE 050/12  
 12,5 cm/4<sup>3</sup>/<sub>4</sub>"

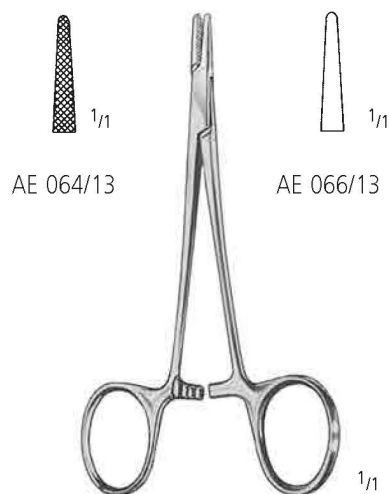

**HALSEY**  
 13,0 cm/5"



**RYDER/FRENCH-EYE**  
 AE 430/13  
 13,0 cm/5"



**DERF**  
 AE 450/12  
 12,5 cm/4<sup>3</sup>/<sub>4</sub>"



**HALSEY**  
 13,0 cm/5"

NAHT SUTURE SUTURA SUTURE SUTURA

Nadelhalter mit Hartmetalleinsätzen  
 Needle Holders with Tungsten Carbide Inserts  
 Porta-agujas con bocas de carburo de tungsteno  
 Porte-aiguilles à mors en carbure de tungstène  
 Portaghi con placche di carburo di tungsteno

T = TITAN



AE 570/14



AE 571/14

**CASTROVIEJO**  
 14,0 cm/5 1/2"



AE 572/14  
 AE 572/14 T



AE 573/14

**CASTROVIEJO**  
 14,0 cm/5 1/2"



AE 576/18



AE 577/18

18,0 cm/7"



AE 578/18



AE 579/18

18,0 cm/7"

AA  
 AB  
 AC  
 AD  
**AE**  
 AK  
 AR  
 KA  
 KM  
 KO  
 KP  
 XR

**AE** NAHT SUTURE SUTURA SUTURE SUTURA

Mikro-Nadelhalter mit Hartmetalleinsätzen  
 Micro-Needle Holders with Tungsten Carbide Inserts  
 Micro-porta-agujas con bocas de carburo de Tungsteno  
 Micro-porte-aiguilles à mors en carbure de tungstène  
 Micro-portaghi con placche di carburo di tungsteno



**JACOBSON**  
 21,0 cm/8<sup>1</sup>/<sub>4</sub>"

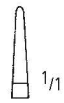

AE 580/01

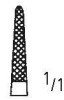

AE 580/02  
 AE 580/02 T

**T = TITAN**



**DIETRICH**

nopa®  
**TUR**

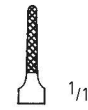

AE 582/16  
 16,0 cm/6<sup>1</sup>/<sub>4</sub>"

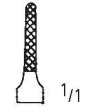

AE 582/18  
 18,0 cm/7"

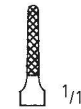

AE 582/20  
 20,0 cm/8"

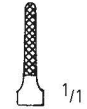

AE 582/23  
 23,0 cm/9"



AE 582/26  
 26,0 cm/10<sup>1</sup>/<sub>4</sub>"



**KALT**  
 AE 584/14  
 13,5 cm/5<sup>1</sup>/<sub>4</sub>"



**CASTROVIEJO**  
 AE 586/13  
 13,0 cm/5<sup>1</sup>/<sub>4</sub>"



**POTTS-SMITH**  
 AE 588/22  
 22,0 cm/8<sup>3</sup>/<sub>4</sub>"

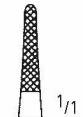

NAHT SUTURE SUTURA SUTURE SUTURA

Mikro-Nadelhalter mit Rundgriff  
 Micro-Needle-Holders with pen-type handle  
 Micro-porta-agujas con mango redondo  
 Micro-porte-aiguilles à manches rondes  
 Micro-portaghi con manici rotondi

AA  
 AB  
 AC  
 AD  
 AE  
 AK  
 AR  
 KA  
 KM  
 KO  
 KP  
 XR

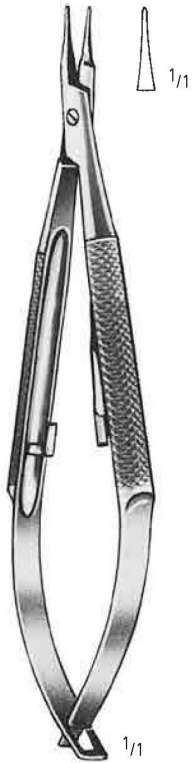

**BARRAQUER-  
TROUTMAN**  
 AE 600/10  
 10,0 cm/4"

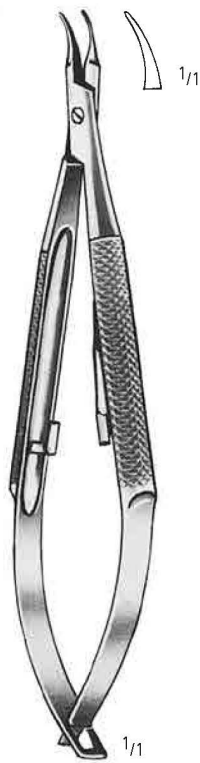

**BARRAQUER-  
TROUTMAN**  
 AE 601/10  
 10,0 cm/4"



**BARRAQUER-  
TROUTMAN**  
 AE 602/10  
 10,0 cm/4"



**BARRAQUER-  
TROUTMAN**  
 AE 603/10  
 10,0 cm/4"



**BARRAQUER**  
 AE 605/11  
 11,0 cm/4 1/4"



**BARRAQUER**  
 AE 605/13  
 13,0 cm/5"



**BARRAQUER**  
 AE 605/14  
 14,0 cm/5 1/2"



**BARRAQUER**  
 AE 606/14  
 14,0 cm/5 1/2"

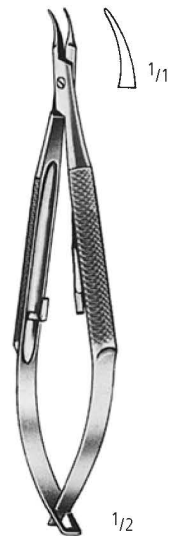

**BARRAQUER**  
 AE 607/14  
 14,0 cm/5 1/2"

**AE** NAHT SUTURE SUTURA SUTURE SUTURA

Mikro-Nadelhalter mit Rundgriff  
 Micro-Needle-Holders with pen-type handle  
 Micro-porta-agujas con mango redondo  
 Micro-porte-aiguilles à manches rondes  
 Micro-portaghi con manici rotondi



**TROUTMAN**  
 AE 609/01  
 12,0 cm/4<sup>3</sup>/<sub>4</sub>"



**TROUTMAN**  
 AE 609/02  
 12,0 cm/4<sup>3</sup>/<sub>4</sub>"



AE 610/15

AE 611/15



AE 612/15

AE 613/15

**REILL**  
 15,0 cm/6"

**REILL**  
 15,0 cm/6"



NAHT SUTURE SUTURA SUTURE SUTURA

Mikro-Nadelhalter  
 Micro-Needle-Holders  
 Micro-porta-agujas  
 Micro-porte-aiguilles  
 Micro-portaghi

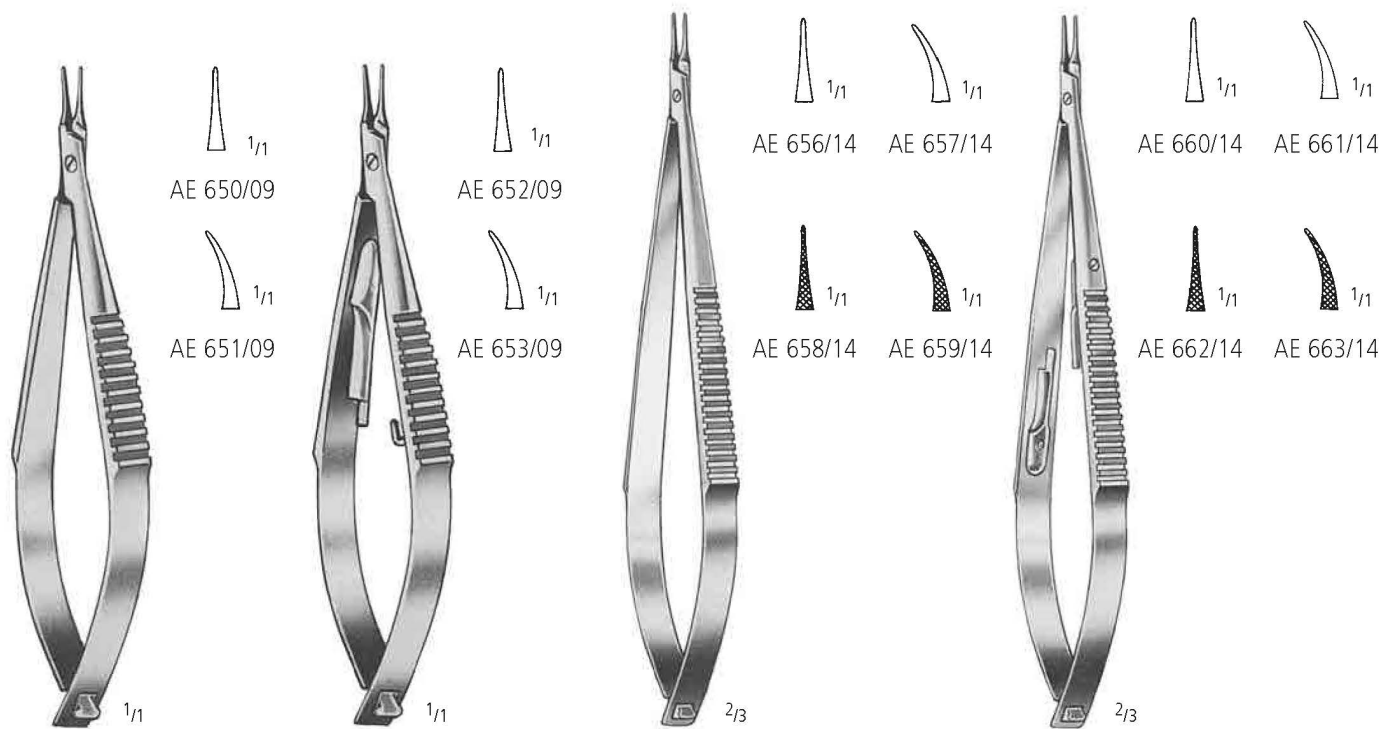

**CASTROVIEJO**  
 9,0 cm/3 1/2"

**CASTROVIEJO**  
 9,0 cm/3 1/2"

**CASTROVIEJO**  
 14,0 cm/5 1/2"

**CASTROVIEJO**  
 14,0 cm/5 1/2"

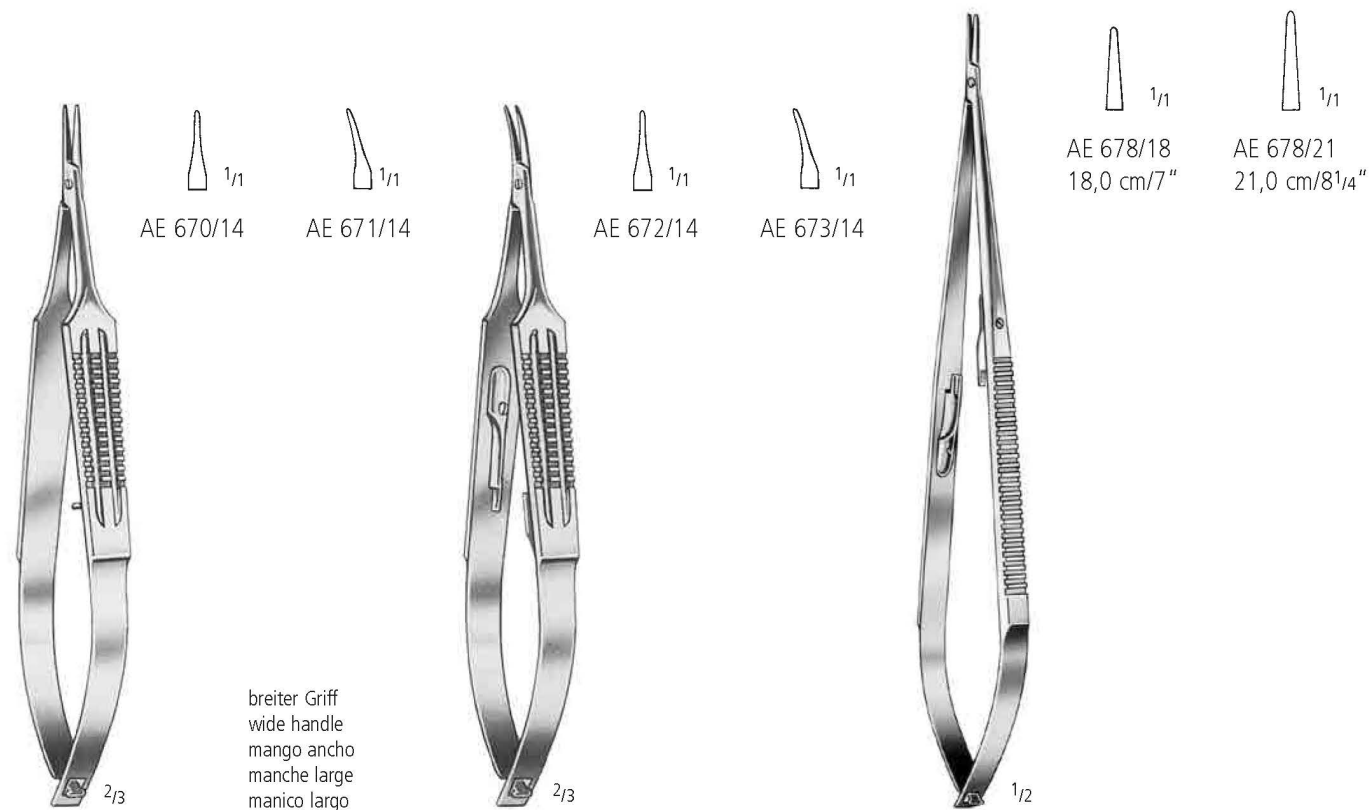

**CASTROVIEJO**  
 14,0 cm/5 1/2"

**CASTROVIEJO**  
 14,0 cm/5 1/2"

**JACOBSON**

breiter Griff  
 wide handle  
 mango ancho  
 manche large  
 manico largo

AA  
 AB  
 AC  
 AD  
**AE**  
 AK  
 AR  
 KA  
 KM  
 KO  
 KP  
 XR



**AE** NAHT SUTURE SUTURA SUTURE SUTURA

Mikro-Nadelhalter  
 Micro-Needle-Holders  
 Micro-porta-agujas  
 Micro-porte-aiguilles  
 Micro-portaghi



**PATON**  
 AE 684/11  
 11,0 cm/4<sup>1</sup>/<sub>2</sub>"



**PATON**  
 AE 685/11  
 11,0 cm/4<sup>1</sup>/<sub>2</sub>"

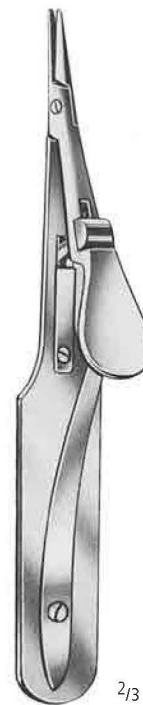

**ARRUGA**  
 14,0 cm/5<sup>1</sup>/<sub>2</sub>"



AE 686/14

AE 687/14



**KALT**  
 AE 688/14  
 14,0 cm/5<sup>1</sup>/<sub>2</sub>"

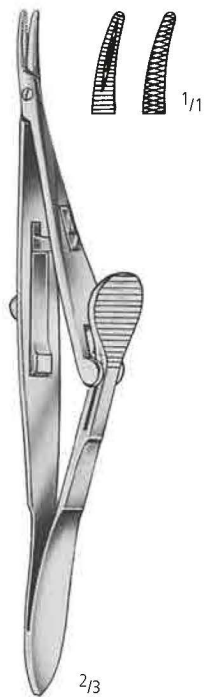

**KALT-ARRUGA**  
 AE 689/14  
 14,0 cm/5<sup>1</sup>/<sub>2</sub>"



**CASTROVIEJO-KALT**  
 AE 690/14  
 13,5 cm/5<sup>1</sup>/<sub>4</sub>"



**STEVENS**  
 AE 692/13  
 13,0 cm/5"



AE 692/15

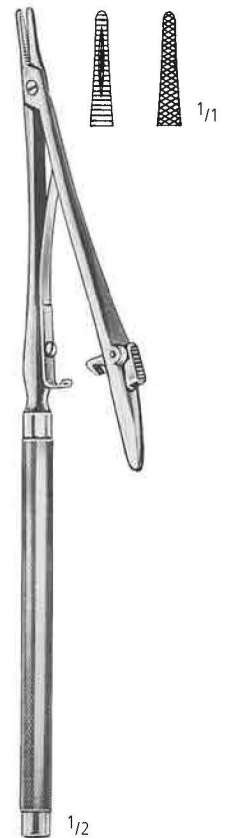

**POTTS-SMITH**  
 AE 694/22  
 22,0 cm/8<sup>3</sup>/<sub>4</sub>"

NAHT SUTURE SUTURA SUTURE SUTURA

Mikro-Nadelhalter mit Rundgriff  
 Micro-Needle-Holders with pen-type handle  
 Micro-porta-agujas con mango redondo  
 Micro-porte-aiguilles à manches rondes  
 Micro-portaghi con manici rotondi

AA  
 AB  
 AC  
 AD  
 AE  
 AK  
 AR  
 KA  
 KM  
 KO  
 KP  
 XR

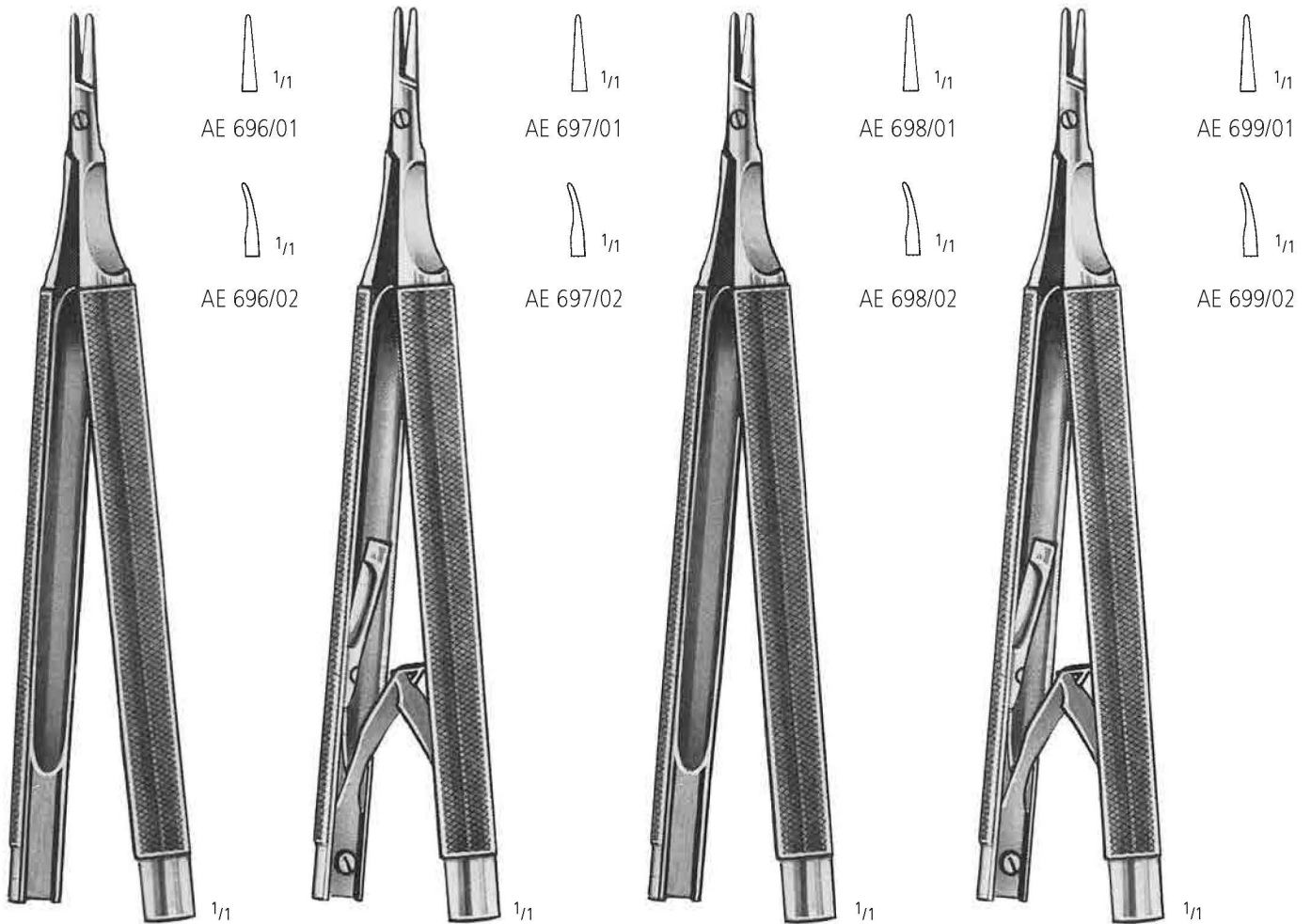

**CASTROVIEJO**  
 13,0 cm/5 1/4"

**CASTROVIEJO**  
 13,0 cm/5 1/4"

**CASTROVIEJO**  
 13,0 cm/5 1/4"

**CASTROVIEJO**  
 13,0 cm/5 1/4"

Ø Griff 8 mm  
 Ø Handle 8 mm  
 Ø Mango 8 mm  
 Ø Manche 8 mm  
 Ø Manico 8 mm

Ø Griff 10 mm  
 Ø Handle 10 mm  
 Ø Mango 10 mm  
 Ø Manche 10 mm  
 Ø Manico 10 mm



DIAGNOSTIK  
DIAGNOSTICS  
DIAGNOSTICO  
DIAGNOSTIC  
DIAGNOSTICA

AR

nopa<sup>®</sup> instruments

Weitere Naht-Instrumente finden Sie in unserem Katalog „Allgemeines Instrumentarium“ in Gruppe AE.

For further suture instruments kindly refer to our catalogue „General Instruments“, section AE.

Para instrumentos de sutura adicionales, por favor consulte nuestro catálogo de „Instrumental de uso general“, grupo AE.

Pour des instruments de suture supplémentaires, consultez notre catalogue „Instrumentation Generale“, section AE.

Per gli altri accessori di sutura, consultare il nostro catalogo „Strumentazione Generale“, gruppo AE.





Messinstrumente  
Measuring Instruments  
Instrumentos para medidas  
Instruments pour mesurer  
Strumenti per misurare

AA

AB

AC

AD

AE

AK

AR

KA

KM

KO

KP

XR



1/2

AR 250/15  
15,0 cm/6"



1/1

**JAMESON**  
AR 261/08  
0 - 80 mm/0-3 inch



1/1

**CASTROVIEJO**  
AR 282/15  
8,0 cm/3 1/4"

Messbereich 15 mm  
measuring range 15 mm  
campo de medición 15 mm  
étendue de mesurage 15 mm  
ampiezza di misura 15 mm



1/1

**CASTROVIEJO**  
AR 282/20  
8,0 cm/3 1/4"

Messbereich 20 mm  
measuring range 20 mm  
campo de medición 20 mm  
étendue de mesurage 20 mm  
ampiezza di misura 20 mm



1/1

**CASTROVIEJO**  
AR 283/20  
8,0 cm/3 1/4"

Messbereich 20 mm  
measuring range 20 mm  
campo de medición 20 mm  
étendue de mesurage 20 mm  
ampiezza di misura 20 mm



Ophthalmoskop  
 Ophthalmoscope  
 Oftalmoscopio  
 Ophtalmoscope  
 Oftalmoscopio



**OTO- / OPHTHALMOSKOP**  
 AR 402/00



**OPHTHALMOSKOP**  
 AR 420/00

---

OPHTHALMOLOGIE  
OPHTHALMOLOGY  
OFTALMOLOGIA  
OPHTALMOLOGIE  
OFTALMOLOGIA

**KP**

**nopa**<sup>®</sup> instruments





Feine Wundhaken  
Delicate Hooks  
Ganchos  
Crochets très fins  
Divaricatori sottili

AA

AB

AC

AD

AE

AK

AR

KA

KM

KO

KP

XR



**GILLIES**  
AK 020/01  
18,0 cm/7"



**GILLIES**  
AK 020/02  
18,0 cm/7"



**KILNER**  
AK 022/15  
15,0 cm/6"



**FRAZIER**  
AK 024/13  
13,0 cm/5"



AK 026/01



**KLEINERT-KUTZ**  
AK 026/02  
16,0 cm/6¼"



AK 026/03

Feine Wundhaken  
 Delicate Hooks  
 Ganchos  
 Crochets très fins  
 Divaricatori sottili

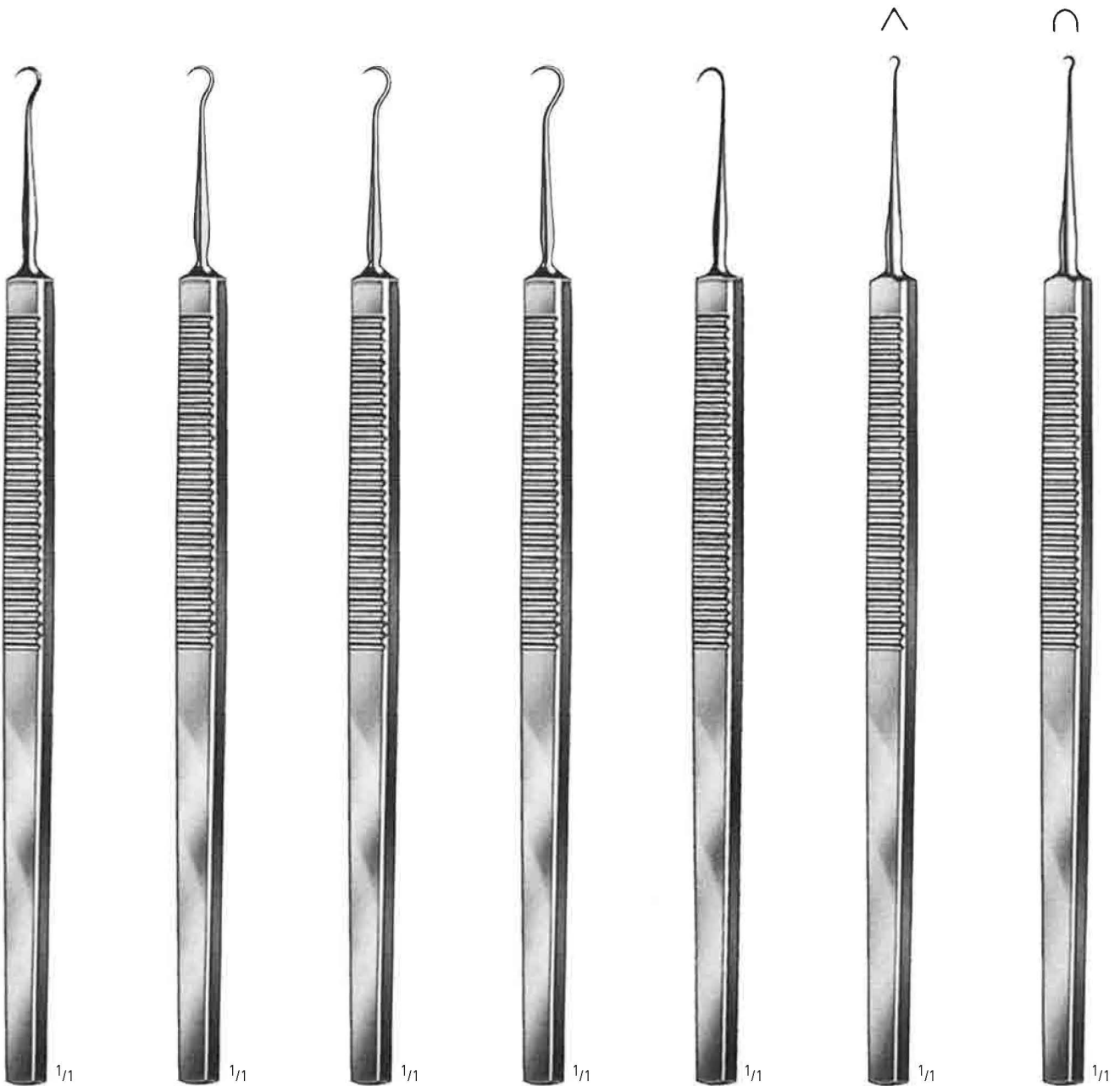

				<b>O' CONNOR</b>	<b>GRAEFE</b>	<b>GRAEFE</b>
AK 028/01	AK 028/02	AK 028/03	AK 028/04	AK 030/16	AK 032/01	AK 032/02
16,0 cm/6 <sup>1</sup> / <sub>4</sub> "	16,0 cm/6 <sup>1</sup> / <sub>4</sub> "	16,0 cm/6 <sup>1</sup> / <sub>4</sub> "	16,0 cm/6 <sup>1</sup> / <sub>4</sub> "	16,0 cm/6 <sup>1</sup> / <sub>4</sub> "	16,0 cm/6 <sup>1</sup> / <sub>4</sub> "	16,0 cm/6 <sup>1</sup> / <sub>4</sub> "

WUNDHAKEN RETRACTORS SEPARADORES ECARTEURS DIVARICATORI

Feine Wundhaken  
Delicate Hooks  
Ganchos  
Crochets très fins  
Divaricatori sottili

AA

AB

AC

AD

AE

AK

AR

KA

KM

KO

KP

XR



**CUSHING**  
28,0 cm/11"



AK 034/01



AK 034/02



**CUSHING**  
19,0 cm/7 1/2"



AK 036/01



AK 036/02

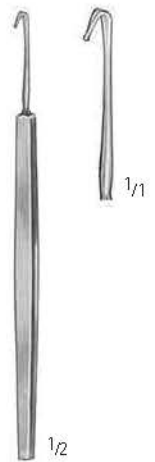

**MOLDESTAD**  
AK 038/13  
13,0 cm/5"



AK 040/05  
5 mm



AK 040/07  
7 mm

17,0 cm/6 3/4"



AK 042/10  
Ø 1,0 mm



AK 042/12  
Ø 1,2 mm

18,5 cm/7 1/8"

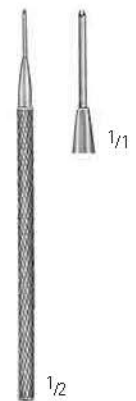

AK 044/11  
11,0 cm/4 1/8"



Feine Wundhaken  
Delicate Hooks  
Ganchos  
Crochets très fins  
Divaricatori sottili

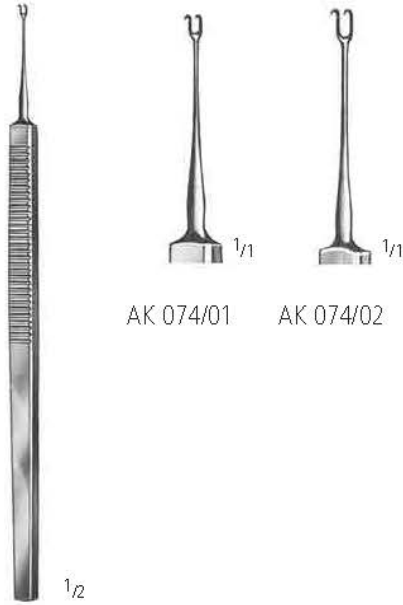

AK 074/01    AK 074/02

**GUTHRIE**  
16,0 cm/6 1/4"



**ROLLET**  
AK 076/13  
13,0 cm/5"

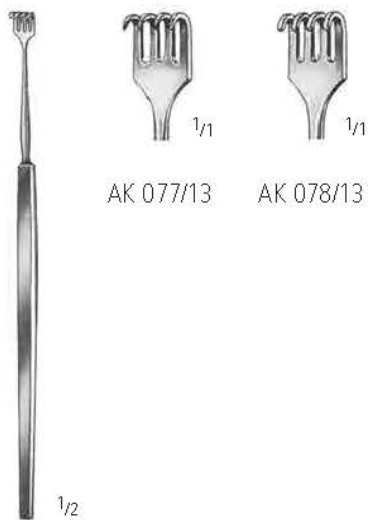

**KNAPP**  
13,0 cm/5"



**DESMARRES**  
13,0 cm/5"



AK 090/08  
8 mm



AK 090/10  
10 mm



AK 090/12  
12 mm



AK 090/14  
14 mm



AK 090/16  
16 mm



AK 090/18  
18 mm

ORTHOPÄDIE ORTHOPAEDICS ORTOPEDIA ORTHOPEDIE ORTOPEDIA

Meißeln, Hammer und Hohlmeißelzangen  
 Chisels, Mallet and Bone Rongeurs  
 Cinceles, Martillo, Pinzas-gubias  
 Ciseaux-burins, Marteau, Pincès-gouges  
 Scalpelli, Martello e Pinze-sgorbie

AA  
 AB  
 AC  
 AD  
 AE  
 AK  
 AR  
 KA  
 KM  
 KO  
 KP  
 XR

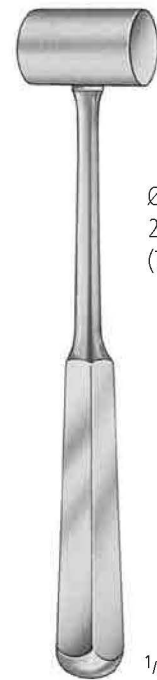

Ø 22 mm  
 200 g  
 (7 oz.)

**PARTSCH**  
 13,5 cm/5 1/4"

**PARTSCH**  
 KA 545/20  
 18,0 cm/7"

- KA 433/02
- KA 433/03
- KA 433/04
- KA 433/05
- KA 433/06
- KA 433/07

mm

- 2
- 3
- 4
- 5
- 6
- 7

- KA 443/02
- KA 443/03
- KA 443/04
- KA 443/05
- KA 443/06
- KA 443/07

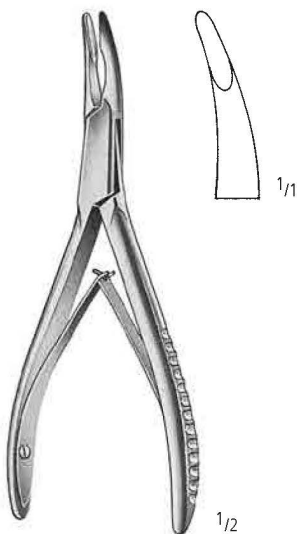

**FRIEDMAN**  
 KA 800/14  
 14,0 cm/5 1/2"

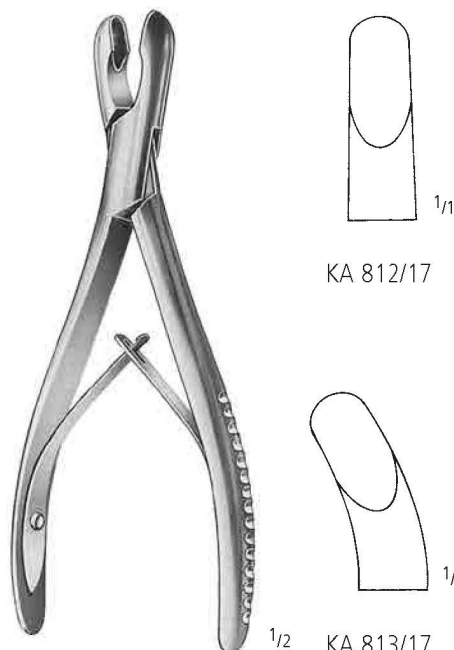

**LUER**  
 17,0 cm/6 3/4"

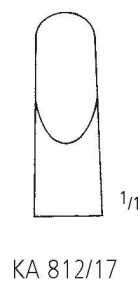

KA 812/17

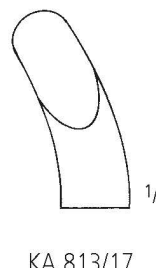

KA 813/17

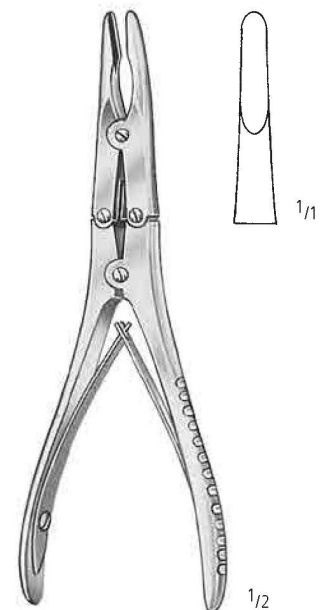

**BÖHLER**  
 KA 825/01  
 15,0 cm/6"

**KM** OHR OTOTOLOGY OTOLOGIA OTOLOGIE OTOLOGIA

Stanzen  
 Punches  
 Pinzas osteótomas  
 Pinces ostéotomes  
 Pinze osteotomi



**CITELLI**



KM 490/01  
 1 mm



KM 490/02  
 2 mm



KM 490/03  
 3 mm

NASE RHINOLOGY RINOLOGIA RHINOLOGIE RINOLOGIA

Nasenspekula, Keilbeinstanzen  
 Nasal Specula, Sphenoid Punches  
 Espéculos nasales, Pinzas para seno esfenoidal  
 Spéculums nasaux, Pinces pour sinus sphénoïdal  
 Specoli nasali, Pinze per seno sfenoidale

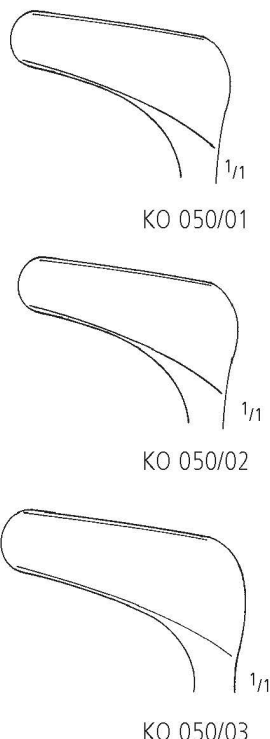

**HARTMANN-HALLE**  
 15,0 cm/6"



**KERRISON**

1/1  
 3 x 3 mm  
 KO 275/90  
 1/1  
 4 x 4 mm  
 KO 276/90  
 1/1  
 5 x 5 mm  
 KO 277/90

Hohlmeißel  
 Gouges  
 Gubias  
 Gouges  
 Sgorbie



**WEST**  
 KO 604/04  
 16,0 cm/6 1/4"



**WEST**  
 KO 605/04  
 16,0 cm/6 1/4"

AA  
 AB  
 AC  
 AD  
 AE  
 AK  
 AR  
 KA  
 KM  
 KO  
 KP  
 XR

Muskel-, Netzhautablösungs- und Schielhaken  
 Muscle, Retinal Detachment and Strabismus Hooks  
 Ganchos de músculos, para desprendimiento de retina y para estrabismo  
 Crochets musculaires, de décollement de la rétine et à strabisme  
 Uncinetti per muscoli e per strabismo



**GREEN**  
 KP 001/13  
 13,0 cm/5"

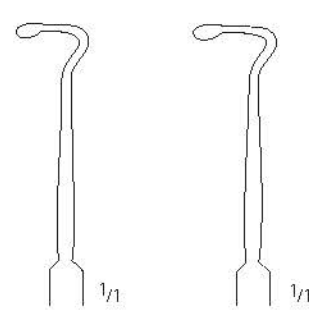
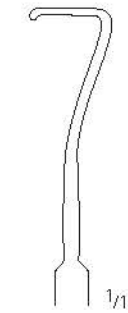

**JAMESON**  
 KP 002/12 12,0 cm/4¾"  
 KP 002/13 13,0 cm/5"

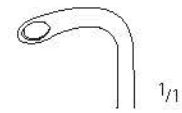

**GASS**  
 KP 010/14  
 14,0 cm/5½"

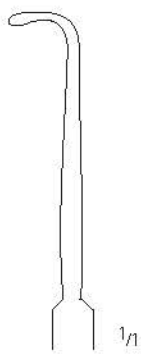

**GRAEFE**  
 KP 015/01  
 13,0 cm/5"  
 Fig. 1

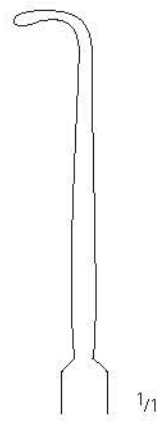

**GRAEFE**  
 KP 015/02  
 14,0 cm/5½"  
 Fig. 2

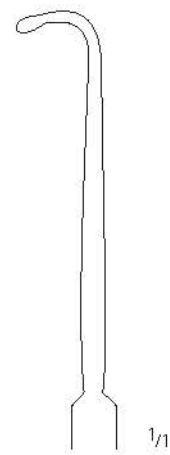

**GRAEFE**  
 KP 015/03  
 15,0 cm/6"  
 Fig. 3

Sehnenhäkchen, Fixiergabel  
 Tenotomy Hook, Fixation Fork  
 Gancho de tenotomía, Horquilla fijadora  
 Crochet pour tenotomie, Pique de fixation  
 Uncinetti de tendini e per fissazione

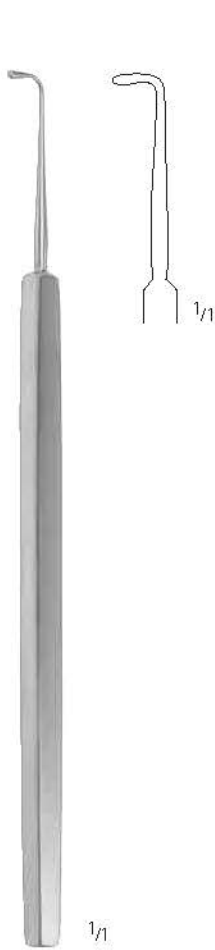

**STEVENS**  
 KP 018/12  
 12,0 cm/4¾"



**BURCH**  
 KP 020/13  
 13,0 cm/5"



KP 023/01  
 11,0 cm/4½"

rechts  
 right  
 derecha  
 droit  
 destra

KP 023/02  
 11,0 cm/4½"

links  
 left  
 izquierda  
 gauche  
 sinistra

AA  
 AB  
 AC  
 AD  
 AE  
 AK  
 AR  
 KA  
 KM  
 KO  
 KP  
 XR



Irishäkchen  
Iris Hooks  
Ganchos para iris  
Crochets à iris  
Uncinetti per l'iride



sehr fein, scharf  
very delicate, pointed  
delicadísimo, afilado  
très fin, coupant  
fino, tagliente

**BONN**  
KP 025/14  
13,5 cm/5<sup>1</sup>/<sub>4</sub>"



stumpf  
blunt  
romo  
émoussé  
smussato

**KNOLLE**  
KP 026/11  
11,0 cm/4<sup>1</sup>/<sub>2</sub>"

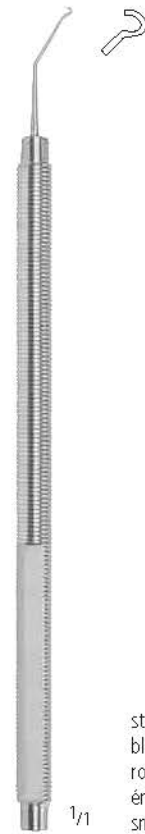

stumpf, abgewinkelt  
blunt, angled  
romo, angular  
émoussé, coudé  
smussato, angolato

**JAFFE-KNOLLE**  
KP 027/12  
12,0 cm/4<sup>3</sup>/<sub>4</sub>"

Irishäkchen  
 Iris Hooks  
 Ganchos para iris  
 Crochets à iris  
 Uncinetti per l'iride

AA

AB

AC

AD

AE

AK

AR

KA

KM

KO

KP

XR



1/1

**TYRELL**  
 12,0 cm/4<sup>3</sup>/<sub>4</sub>"



KP 029/01

stumpf  
 blunt  
 romo  
 émoussé  
 smussato



KP 029/02

scharf  
 pointed  
 afilado  
 coupant  
 tagliente

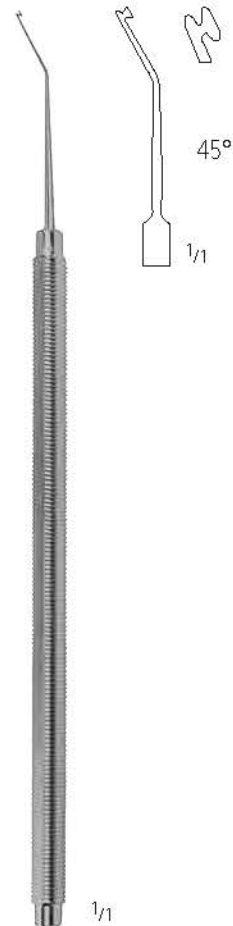

1/1

**HIRSCHMANN**  
 KP 030/13  
 12,5 cm/5"

Linserkernwender, Linsenmanipulator  
 Lens Nucleus Rotators, Lens Manipulators  
 Ganchos para voltear nucleo y para posicionar cristalino  
 Crochets pour tourner, Crochets manipulateurs à cristallin  
 Undinetti per rotazione di nucleo cristallino, Undini per posizionare cristallino

## TITANIUM



1/1



**BECHERT**  
 KP 040/01  
 12,0 cm / 4 3/4"  
 L = 7 mm

V-Spitze  
 V-tip  
 punta V  
 coudé à fourche  
 punta V



**JAFFE-BECHERT**  
 KP 040/02  
 12,0 cm / 4 3/4"  
 L = 9 mm

V-Spitze  
 V-tip  
 punta V  
 coudé à fourche  
 punta V



**CLAYMAN**  
 KP 040/03  
 12,5 cm / 5"  
 L = 10 mm

V-Spitze  
 V-tip  
 punta V  
 coudé à fourche  
 punta V



1/1

**OSHER**  
 KP 050/12  
 12,0 cm / 4 3/4"

Linsenkemmanipulatoren, Phakohaken  
 IOL Manipulators, Phaco Splitter  
 Ganchos para manipular de nucleo, Ganchos para faco  
 Crochets pour manipuler le noyau, Crochets à phaco  
 Uncini per posizionare cristallino, Uncini per faco

AA  
AB  
AC  
AD  
AE  
AK  
AR  
KA  
KM  
KO  
KP  
XR

# TITANIUM



**DRYSDALE**  
 KP 051/12  
 12,0 cm/4<sup>3</sup>/<sub>4</sub>"



**BUNNKATU**  
 KP 057/12  
 12,0 cm/4<sup>3</sup>/<sub>4</sub>"



Klinge  
 blade  
 hoja  
 lame  
 lame

60°

KP 065/60



**ROSEN**  
 12,0 cm/4<sup>3</sup>/<sub>4</sub>"

KP 065/90

stumpfes Eck  
 blunt edge  
 canto romo  
 coin mousse  
 angolo smussato

90°



**NAGAHARA**  
 12,0 cm/4<sup>3</sup>/<sub>4</sub>"

KP 067/90

Klinge  
 blade  
 hoja  
 lame  
 lame

60°

stumpfes Eck  
 blunt edge  
 canto romo  
 coin mousse  
 angolo smussato

90°

IOL Positionshäkchen  
 Lens Manipulators  
 Ganchos para posicionar cristalino  
 Crochets manipulateurs à cristallin  
 Uncini per posizionare cristallino

## TITANIUM

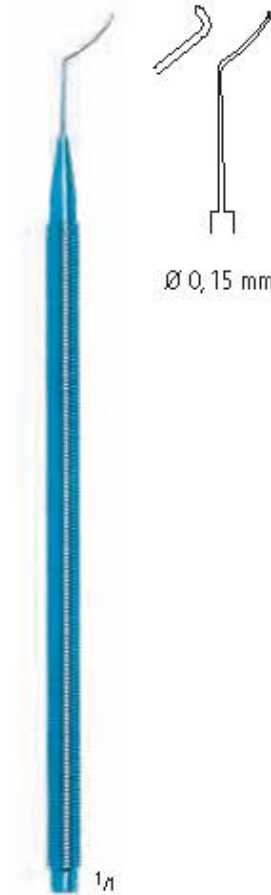

**SINSKEY**  
 12,0 cm/4<sup>3</sup>/<sub>4</sub>"

**LEWICKY**  
 KP 075/15  
 12,0 cm/4<sup>3</sup>/<sub>4</sub>"

KP 070/20

Ø 0,20 mm

KP 071/20

KP 070/25

Ø 0,25 mm

KP 071/25

IOL Positionshäkchen  
 Lens Manipulators  
 Ganchos para posicionar cristalino  
 Crochets manipulateurs à cristallin  
 Uncini per posizionare cristallino

AA  
 AB  
 AC  
 AD  
 AE  
 AK  
 AR  
 KA  
 KM  
 KO  
 KP  
 XR

## TITANIUM



**LESTER**  
 KP 077/01  
 12,0 cm/4<sup>3</sup>/<sub>4</sub>"



KP 077/02  
 12,0 cm/4<sup>3</sup>/<sub>4</sub>"



### LESTER

KP 077/03  
 12,0 cm/4<sup>3</sup>/<sub>4</sub>"

gewölbt  
 vaulted  
 abovedado  
 cintré  
 convesso



### JAFFE-MALTZMANN

KP 081/12  
 12,0 cm/4<sup>3</sup>/<sub>4</sub>"



**RENTSCH**  
 KP 085/12  
 12,0 cm/4<sup>3</sup>/<sub>4</sub>"





Tränenkanalsonden  
 Lacrimal Probes  
 Sondas exploradoras para canal lacrimal  
 Sondes exploratrices pour le canal lacrymal  
 Sonde esploratrici per canale lacrimale

AA

AB

AC

AD

AE

AK

AR

KA

KM

KO

KP

XR



geknöpft  
 pointed  
 con botón  
 boutonné  
 bottenuto

- KP 114/00
- KP 115/00
- KP 115/01
- KP 115/12
- KP 115/23
- KP 115/34
- KP 115/45
- KP 115/56
- KP 115/67
- KP 115/78

Fig.	mm Ø
0000/00	0,4 / 0,6
00/0	0,7 / 0,8
0/1	0,8 / 0,9
1/2	0,9 / 1,1
2/3	1,1 / 1,3
3/4	1,3 / 1,4
4/5	1,4 / 1,5
5/6	1,5 / 1,6
6/7	1,6 / 1,8
7/8	1,8 / 1,9



zylindrisch  
 cylindrical  
 cilindrica  
 cylindrique  
 cilindrico

- KP 116/00
- KP 117/00
- KP 117/01
- KP 117/12
- KP 117/23
- KP 117/34
- KP 117/45
- KP 117/56
- KP 117/67
- KP 117/78



**BOWMAN**  
 12,5 cm/5"

aus Silber  
 Sterling silver  
 de plata pura  
 en argent pur  
 in argento puro

**BOWMAN**  
 12,5 cm/5"

Tränenkanaldilatatore  
 Lacrimal Dilators  
 Dilatadoras para canal lacrimal  
 Dilatateurs pour le canal lacrymal  
 Dilatatori per canale lacrimale



**WILDER**  
 10 cm/4"

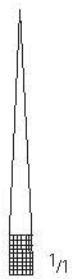

KP 120/01  
 Fig. 1

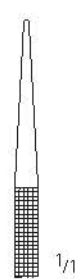

KP 120/02  
 Fig. 2

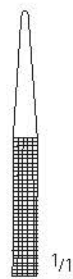

KP 120/03  
 Fig. 3



**MULDOON**  
 KP 121/11  
 10,5 cm/4 1/4"

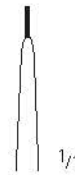

**RUEDEMANN**  
 KP 122/07  
 7 cm/2 3/4"

Tränenkanaldilatatoren, Trabekularsonden, Pigtail Sonde  
 Lacrimal Dilators, Trabecular Probes, Pigtail Probe  
 Dilatadoras para canal lacrimal, Sondas trabeculares, Sonda pigtail  
 Dilateurs pour le canal lacrymal, Sondes trabéculaires, Sonde spiralée  
 Dilatatori per canale lacrimale, Sonde trabecolari, Sonda a pigtail

AA

AB

AC

AD

AE

AK

AR

KA

KM

KO

KP

XR



**CASTROVIEJO**  
 KP 123/14  
 14 cm/5 1/2"



KP 130/01

rechts  
 right

derecha  
 droit  
 destra

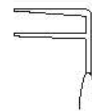
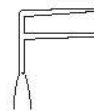

**HARMS**  
 4,5 cm/1 3/4"

KP 130/02

links  
 left

izquierda  
 gauche  
 sinistra

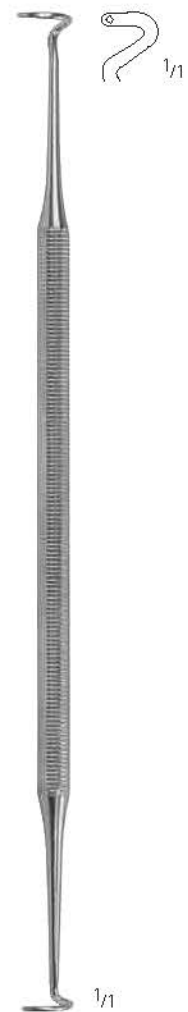

**WORST**  
 KP 135/14  
 13,5 cm/5 1/4"

Lidsperrer  
Eye Specula  
Blefarostatos  
Bléfarostats  
Blefarostati

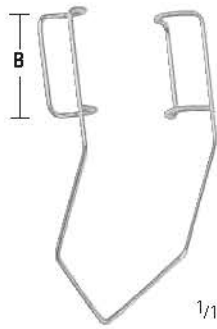

**BARRAQUER-COLIBRI**

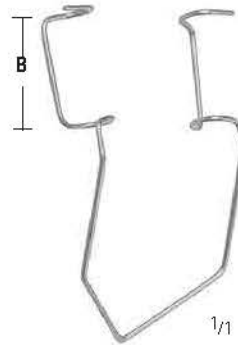

**KRATZ-BARRAQUER**

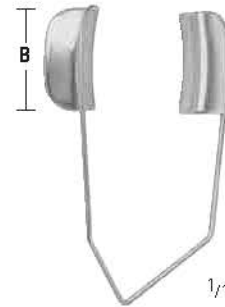

**BARRAQUER**

geschlossene Valven  
solid blades  
hojas sólidas  
cuillers plaines  
valve massiccio

Frühgeborene  
Premature infant  
Parto prematuro  
Acouchement prématuré  
Parto prematuro

**B**  
5 mm KP 150/05  
3,0 cm/1 1/4"

**B**  
10 mm KP 151/10  
4,0 cm/1 1/2"

**B**  
10 mm KP 152/10  
4,0 cm/1 1/2"

Kind  
Child  
Niños  
Enfants  
Bambini

10 mm KP 150/10  
3,0 cm/1 1/4"

10 mm KP 151/10  
4,0 cm/1 1/2"

10 mm KP 152/10  
4,0 cm/1 1/2"

Erwachsene  
Adults  
Adultos  
Adultes  
Adulti

15 mm KP 150/15  
4,0 cm/1 1/2"

14 mm KP 151/14  
4,5 cm/1 3/4"

15 mm KP 152/15  
4,0 cm/1 1/2"



**BARRAQUER PHAKO**  
KP 154/04  
4,0 cm/1 1/2"

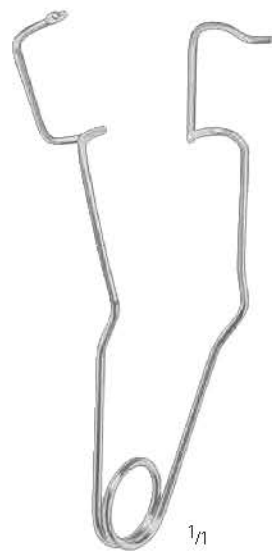

**BOWMAN**  
KP 160/07  
7,0 cm/2 3/4"

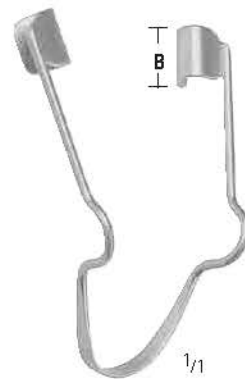

**CORCELLE**  
KP 161/05  
5,0 cm/ 2"  
**B** = 8 mm



**WILLIAMS**  
KP 162/09  
9,0 cm/3 1/2"  
**B** = 14 mm

Lidsperer  
Eye Specula  
Blefarostatos  
Blépharostats  
Blefarostati

AA

AB

AC

AD

AE

AK

AR

KA

KM

KO

KP

XR

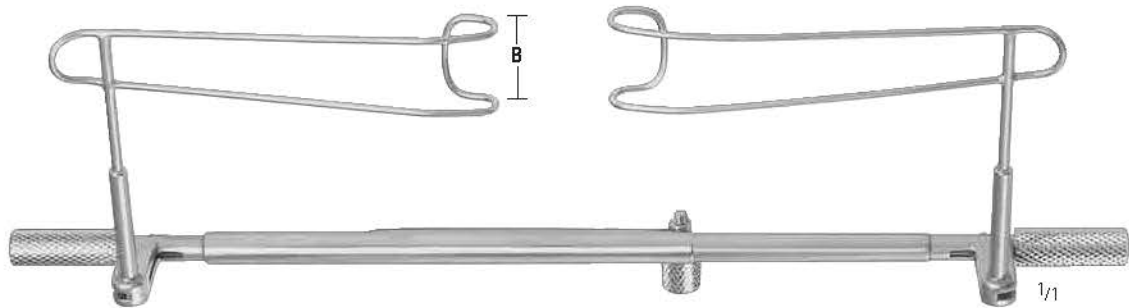

**SCHOTT**  
15,0 cm/6"

Kind  
Child  
Niños  
Enfants  
Bambini

**B**  
12 mm KP 170/12

Erwachsene  
Adults  
Adultos  
Adultes  
Adulti

**B**  
15 mm KP 170/15



**CASTROVIEJO**  
KP 175/09  
9,0 cm/3 1/2"  
**B** = 16 mm



**MAUMENEE-PARK**  
KP 176/09  
8,5 cm/3 1/4"

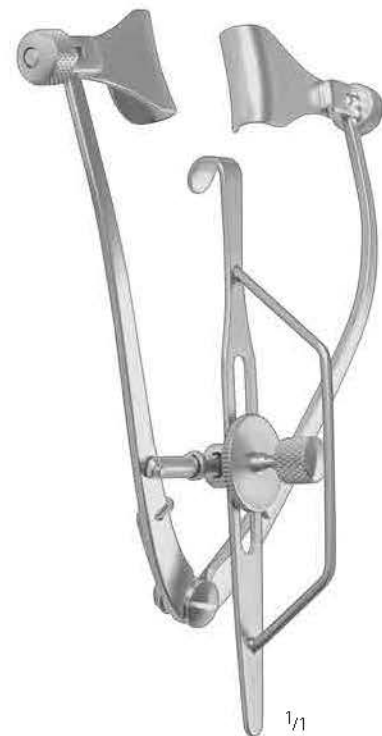

**MAUMENEE-PARK**  
KP 177/09  
8,5 cm/3 1/4"



Lidsperrer  
Eye Specula  
Blefarostatos  
Blépharostats  
Blefarostati

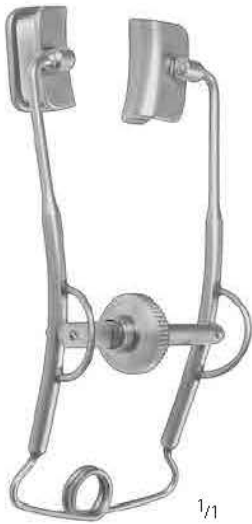

**PLEY**  
KP 185/07  
6,5 cm/2 1/2"

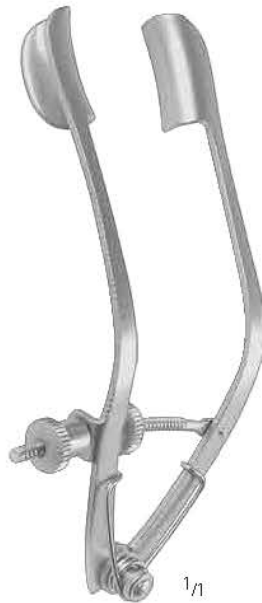

**LANCASTER**  
KP 186/08  
8,0 cm/3 1/4"



**LESTER-BURCH**  
KP 187/08  
8,0 cm/3 1/4"



**COOK**

	<b>B</b>	
Kind	10 mm	KP 200/10
Child		4,0 cm/1 1/2"
Niños		
Enfants		
Bambini		
Erwachsene	15 mm	KP 200/15
Adults		5,0 cm/ 2"
Adultos		
Adultes		
Adulti		

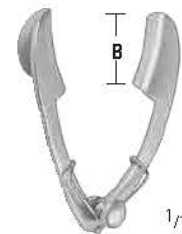

**SAUER**

	<b>B</b>	
Kind	8 mm	KP 205/08
Child		3,0 cm/1 1/4"
Niños		
Enfants		
Bambini		

Lidsperrer  
Eye Specula  
Blefarostatos  
Blépharostats  
Blefarostati

AA

AB

AC

AD

AE

AK

AR

KA

KM

KO

KP

XR



V-förmig  
V-shaped  
forma V  
forme V  
forme V

**LIEBERMAN**  
KP 210/01  
8,0 cm/3 1/4"  
**B** = 15 mm



K-förmig  
K-shaped  
forma K  
forme K  
forme K

**LIEBERMAN**  
KP 210/02  
8,0 cm/3 1/4"  
**B** = 15 mm



**LIEBERMAN**  
KP 211/08  
8,0 cm/3 1/4"  
**B** = 15 mm



**LIEBERMAN**  
KP 212/08  
8,0 cm/3 1/4"  
**B** = 15 mm

Tränensackspreizer, Lidplatte  
 Lacrimal Sac Retractors, Lid Plate  
 Separadores para saco lacrimal, Placa para párpados  
 Ecarteurs à sac lacrymal, Plaque à paupières  
 Divaricatore per sacco lacrimale, Elevatori per palpebre

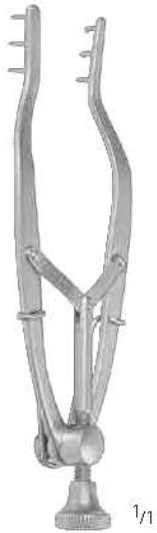

**STEVENSON**  
 KP 230/08  
 7,5 cm/3"



**AGRICOLA**  
 KP 232/05  
 4,5 cm/1<sup>3</sup>/<sub>4</sub>"



Paar  
 Pair  
 Par  
 Paire  
 Paio

**JAFFE**  
 4,0 cm/1<sup>1</sup>/<sub>2</sub>"

**B**  
 10 mm KP 245/10  
 Kind  
 Child  
 Niños  
 Enfants  
 Bambini

**B**  
 15 mm KP 245/15  
 Erwachsene  
 Adults  
 Adultos  
 Adultes  
 Adulti



**JAEGER**  
 KP 248/11  
 11,0 cm/4<sup>1</sup>/<sub>2</sub>"

Orbitalretractoren und -spatel, Wundlöffel  
 Orbital Retractors and Spatulas, Protector  
 Separadores y espátulas orbitales, Protector  
 Ecarteurs et spatules à orbite, Protecteur  
 Divaricatori orbitale, Spatole per orbita, Protettore

AA  
 AB  
 AC  
 AD  
 AE  
 AK  
 AR  
 KA  
 KM  
 KO  
 KP  
 XR

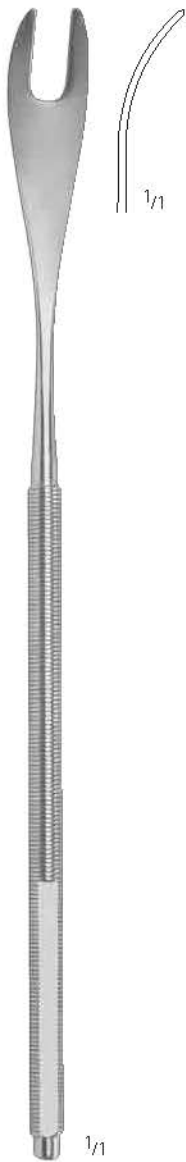

**SCHEPENS**  
 KP 260/16  
 15,5 cm/6¼"

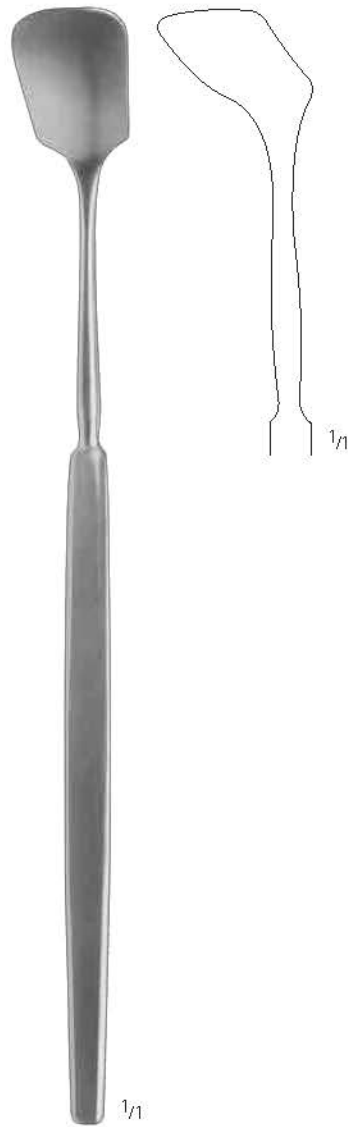

**SAUTTER**  
 KP 261/15  
 15,0 cm/6"



**ARRUGA**  
 KP 262/13  
 13,0 cm/5"



**LASIK**  
 KP 270/10  
 10,0 cm/4"

Depressor, Sklera Marker  
 Depressors, Scleral Markers  
 Depresores, Marcadores de esclerótica  
 Dépresseurs, Marqueur scléral  
 Depressore, Marcadori sclerali



**SCHOCKET**  
 KP 280/14  
 14,0 cm/5 1/2"



1/1

**GASS**  
 KP 285/05  
 4,5 cm/1 3/4"  
 Ø 1,5 mm



1/1

**SCHEPENS**  
 4,0 cm/1 1/2"

KP 290/08  
 Fig. 8

KP 290/10  
 Fig. 10

KP 290/12  
 Fig. 12

klein  
 small  
 pequeño  
 petit  
 piccolo

medium  
 medium  
 medio  
 moyen  
 medio

groß  
 large  
 grande  
 grand  
 grande

Hornhautmesser und -schaber, Diszisionmesser  
 Corneal Knives and Scarifiers, Discission Knives  
 Cuchillos y Rescadores para la córnea, Cuchillos para discisión  
 Kératomes, Grattoirs cornéés, Couteaux à discision  
 Coltelli per cornea, Raschiatoi corneali, Coltelli per discissione

AA  
AB  
AC  
AD  
AE  
AK  
AR  
KA  
KM  
KO  
KP  
XR



**SATO**  
 KP 300/12  
 12,0 cm/ 4¾"  
 5 mm



**GILL**  
 KP 302/13  
 12,5 cm/4½"  
 3 mm

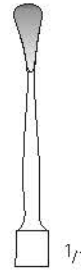

KP 303/12  
 11,5 cm/ 5"  
 3 mm

gerade  
 straight  
 recto  
 droit  
 rette

gebogen  
 curved  
 curvas  
 courbes  
 curve

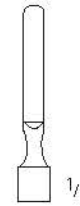

**TOOK**  
 KP 305/11  
 11,0 cm/ 4¼"  
 3 x 18 mm

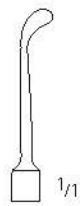

**KUHNT**  
 KP 309/11  
 11,0 cm/ 4¼"  
 3 x 5 mm

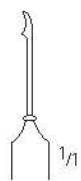

**ZIEGLER**  
 KP 310/03  
 3 mm

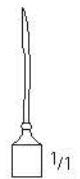

KP 310/05  
 5 mm

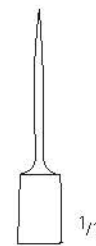

**WHEELER**  
 KP 312/11  
 11,0 cm/ 4¼"  
 1 x 18 mm



Star-, Sklera-, Goniotomiemesser  
 Cataract, Sclera and Goniotomy Knives  
 Cuchillos para catarata, para esclerótica, para goniotomía  
 Couteaux à cataracte, pour la sclère, à goniotomie  
 Coltelli per cataratta, sclerali e per goniotomia

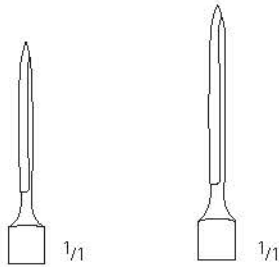

KP 320/20  
 12,0 cm / 4<sup>3</sup>/<sub>4</sub>"  
 20 mm

KP 320/25  
 12,5 cm / 5"  
 25 mm

**GRAEFE**

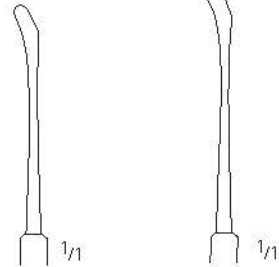
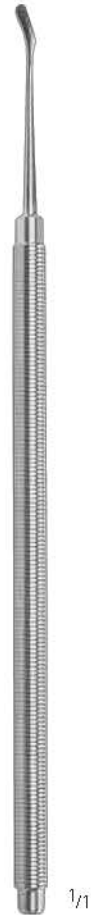

KP 325/05  
 12,5 cm / 5"  
 5 mm

KP 325/06  
 12,5 cm / 5"  
 6 mm

**BONN**

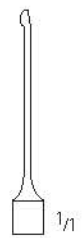
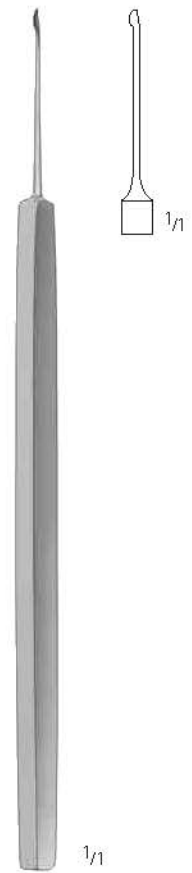

**BARKAN**  
 KP 330/12  
 12,0 cm / 4<sup>3</sup>/<sub>4</sub>"  
 2 mm

Luftlanze, Keratoplastikmesser, Zystotome  
 Keratome, Keratoplasty Knives, Cystotomes  
 Querátomo, Cuchillos para queratoplástica, Quistótomos  
 Couteaux lancéolaires, Couteaux pour kératoplastie, Cystotomes  
 Coltelli lanceolari, Coltelli per cheratoplastica, Cistotomi

AA

AB

AC

AD

AE

AK

AR

KA

KM

KO

KP

XR



**MOD. HAMBURG**  
 KP 335/12  
 12,0 cm/ 4<sup>3</sup>/<sub>4</sub>"



**PAUFIQUE**  
 KP 340/11  
 10,5 cm/ 4<sup>1</sup>/<sub>4</sub>"

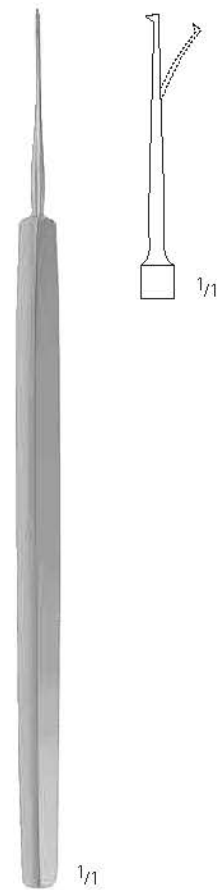

**GRAEFE**  
 KP 346/13  
 12,5 cm/ 5"

biegsam  
 malleable  
 maleable  
 malléable  
 malleabile

Fremdkörpernadeln, -hohlmeißel und -meißel  
 Foreign Body Needles, Gouges and Spuds  
 Agujas, Gubias y Cinceles para cuerpos extraños  
 Aiguilles, Gouges et Ciseaux-burins à corps étrangers  
 Aghi, Sgorbie e Scalpelli per corpi estranei



KP 350/12

umschraubbar  
 reversible  
 reversible  
 réversible  
 rivoltabile



KP 350/13

umschraubbar  
 reversible  
 reversible  
 réversible  
 rivoltabile



1/1



KP 351/01



KP 351/02



KP 351/03

Fremdkörpernadeln und -meißel  
 Foreign Body Needles and Spuds  
 Agujas y Cinceles para cuerpos extraños  
 Aiguilles et Ciseaux-burins à corps étrangers  
 Aghi e Scalpelli per corpi estranei

AA

AB

AC

AD

AE

AK

AR

KA

KM

KO

KP

XR



KP 354/12  
 12,0 cm / 4<sup>3</sup>/<sub>4</sub>"



KP 355/12  
 12,0 cm / 4<sup>3</sup>/<sub>4</sub>"

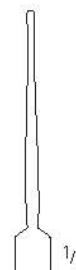

**DAVIS**  
 KP 360/12  
 12,0 cm / 4<sup>3</sup>/<sub>4</sub>"

scharf, rund  
 sharp, round  
 afilado, redondo  
 coupant, rond  
 tagliente, rotondo

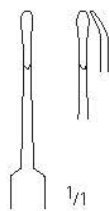

**ELLIS**  
 KP 361/12  
 11,5 cm / 4<sup>1</sup>/<sub>2</sub>"

gebogen, rund  
 curved, round  
 curvado, redondo  
 courbe, rond  
 curvo, rotondo



**FRANCIS**  
 KP 363/12  
 12,0 cm / 4<sup>3</sup>/<sub>4</sub>"



**GOLF-CLUB**  
 KP 364/12  
 11,5 cm / 4<sup>1</sup>/<sub>2</sub>"

Fremdkörpernadeln, -hohlmeißeln und -meißeln, Augenmagnet mit Fremdkörperschlinge  
 Foreign Body Needles, Gouges and Spuds, Magnetic Eye Probe with Foreign Body Loop  
 Agujas, Gubias y Cinceles para cuerpos extraños, Imán oftálmico con asa para cuerpos extraños  
 Aiguilles, Gouges et Ciseaux-burins à corps étrangers, Aimant oculaire avec anse pour corps étrangers  
 Aghi, Sgorbie e Scalpelli per corpi estranei, Calamita per occhi con ansa per corpi estranei

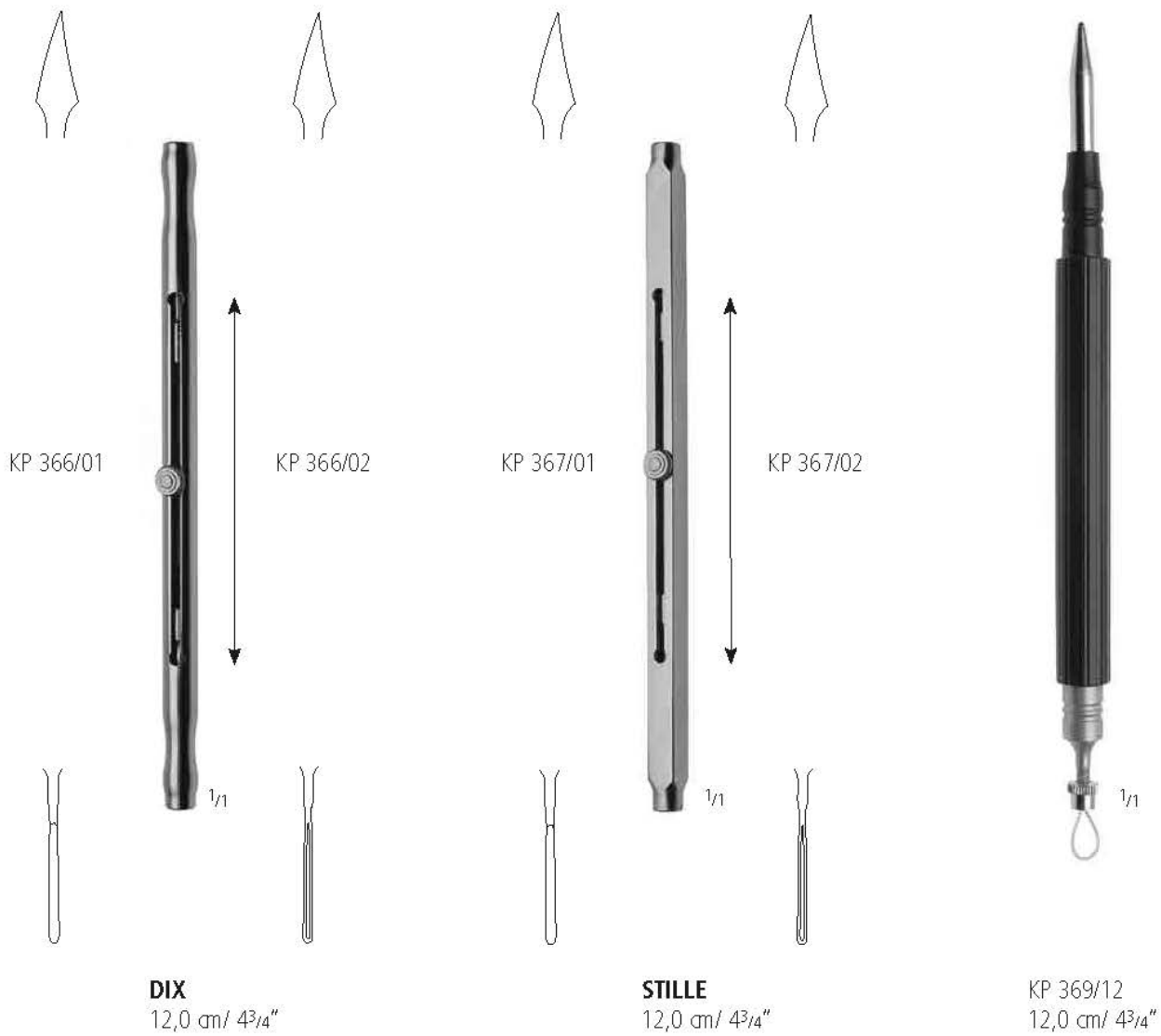

Diamantmesser  
 Diamond Knives  
 Bisturís de diamante  
 Couteaux de diamant  
 Coltelli di diamanti

AA

AB

AC

AD

AE

AK

AR

KA

KM

KO

KP

XR

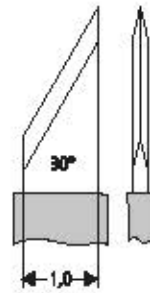

KP 370/01

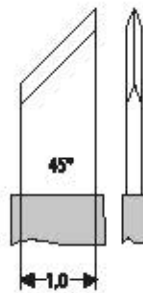

KP 370/02

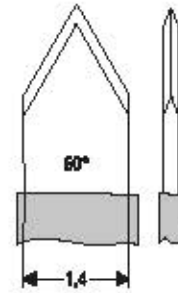

KP 370/03

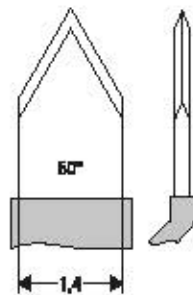

KP 370/04

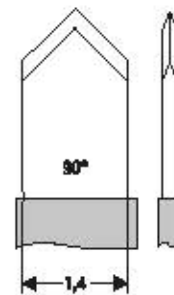

KP 370/05

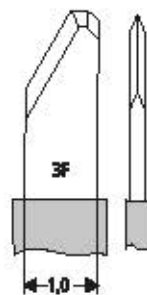

KP 371/01

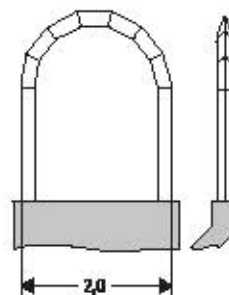

KP 371/02



1/1



Diamantmesser  
 Diamond Knives  
 Bisturís de diamante  
 Couteaux de diamant  
 Coltelli di diamanti

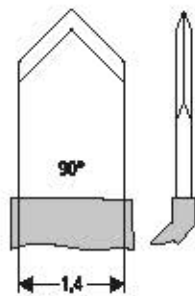

KP 373/01

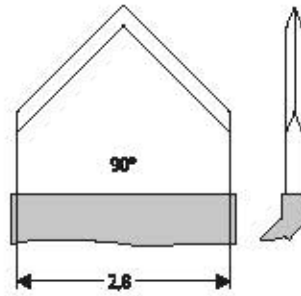

KP 373/02

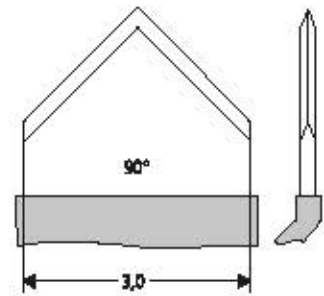

KP 373/03



1/1

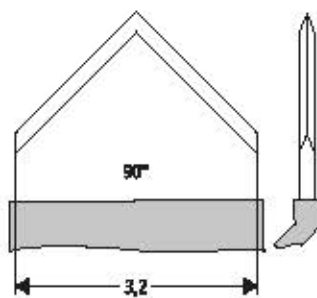

KP 373/04

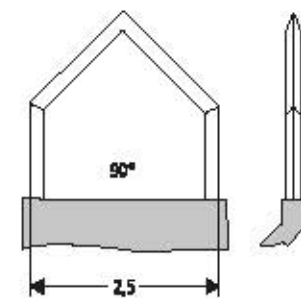

KP 373/05

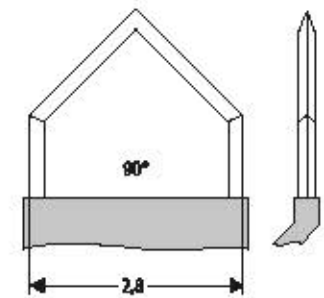

KP 373/06

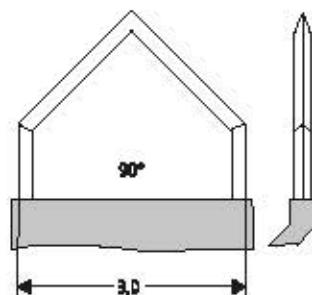

KP 373/07

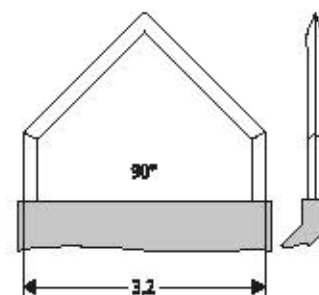

KP 373/08

Diamantmesser  
Diamond Knives  
Bisturís de diamante  
Couteaux de diamant  
Coltelli di diamanti

AA

AB

AC

AD

AE

AK

AR

KA

KM

KO

KP

XR



1/1

mit Mikrometer  
with micrometer  
con micrómetro  
avec micromètre  
con micrometro

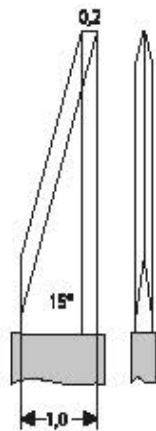

KP 375/01

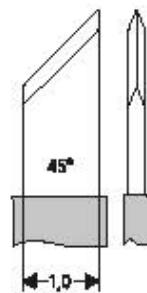

KP 375/02

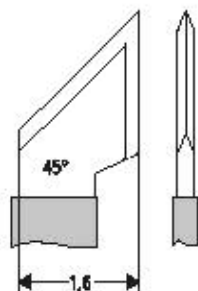

KP 375/03



1/1

7 Stufen:  
7 steps:  
7 escalones:  
7 étages:  
7 g radi:

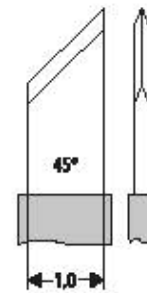

KP 376/01

0 / 0,3 / 0,4 / 0,5 / 0,6 / 0,8 / 1,0 / 2,5 mm

Vitrektomiescheren  
 Vitrectomy Scissors  
 Tijeras de vitrectomía  
 Ciseaux pour vitrectomie  
 Forbici per vitrectomia



ohne Spülung  
 without irrigation  
 sin irrigaciòn  
 sans irrigation  
 senza irrigazione

mit Spülung  
 with irrigation  
 con irrigaciòn  
 avec irrigation  
 con irrigazione

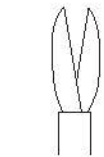

KP 390/00  
 0°

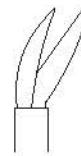

KP 390/30  
 30°

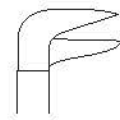

60° KP 390/60  
 90° KP 390/90

Vitrektomiefasszangen  
 Vitrectomy Grasping Forceps  
 Pinzas de vitrectomía  
 Pincas pour vitrectomie  
 Pinze per vitrectomia

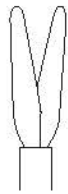

KP 394/00

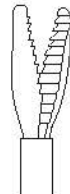

KP 395/01



KP 395/02



KP 395/03



0,30 mm  
0,44 mm

KP 396/30  
KP 396/44

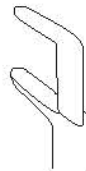

KP 397/45  
45°

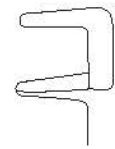

KP 397/90  
90°

AA

AB

AC

AD

AE

AK

AR

KA

KM

KO

KP

XR

Exenterations- und Enukleationslöffel  
 Exenteration- and Enucleation Spoons  
 Cucharas para exenteración y para enucleación  
 Cuillers à éviscération et à énucléation  
 Cucchiari da enucleazione



**BUNGE**

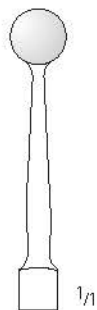

KP 400/01  
14,0 cm/5 1/2"

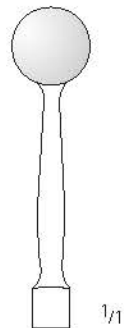

KP 400/02  
14,0 cm/5 1/2"

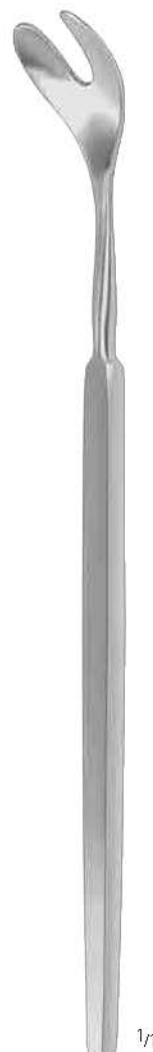

**WELLS**

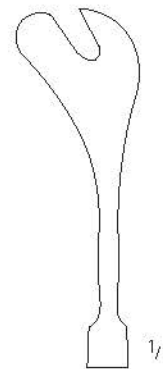

KP 405/14  
14,0 cm/5 1/2"

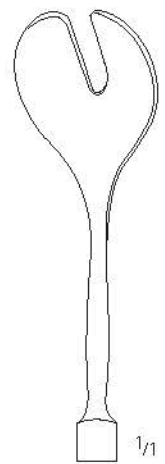

KP 405/15  
15,0 cm/6"

Starlöffel, Chalazionlöffel  
 Corneal Button Transfer Spoon, Chalazion Curettes  
 Cucharas para transferir la córnea, Cucharillas para chalazión  
 Cuillers pour transférer la cornée, Cuillers à chalazion  
 Anse per cristallino, Cucchiari per calazio

AA

AB

AC

AD

AE

AK

AR

KA

KM

KO

KP

XR

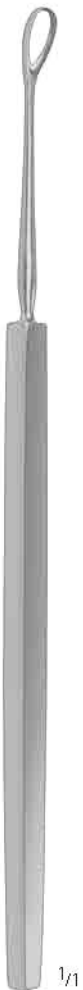

**KNAPP**  
 KP 410/14  
 13,5 cm/5 1/4"

für Hornhauttransfer  
 for corneal button transfer  
 para transferir la córnea  
 pour transférer la cornée  
 per trasferire la cornea

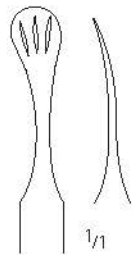

**CASTROVIEJO**  
 KP 411/12  
 12,0 cm/4 3/4"



**MEYHOEFER**  
 13,0 cm/5"



KP 415/10  
 Ø 1,0 mm



KP 415/15  
 Ø 1,5 mm



KP 415/18  
 Ø 1,8 mm



KP 415/20  
 Ø 2,0 mm



KP 415/25  
 Ø 2,5 mm



KP 415/30  
 Ø 3,0 mm



KP 415/35  
 Ø 3,5 mm



Chalazionlöffel, Starlöffel, Starschlingen  
 Chalazion Currettes, Cataract Spoons, Lens Scoops  
 Cucharillas para chalazión y para catarata, Asas para catarata  
 Cuillers à chalazion et à cataracte, Anses à cataracte  
 Cucchiari per calazio, Cucchiari per cataratta, Anse per cataratta

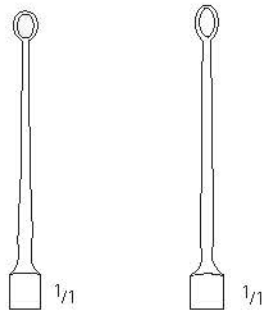

**HEBRA**  
 13,0 cm/5"  
 KP 417/20      KP  
 417/25  
 Ø 2,0 mm      Ø 2,5 mm

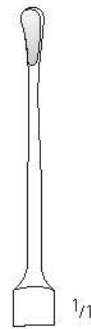

**GRAEFE**  
 KP 425/14  
 13,5 cm/5¼"

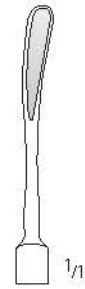

**DAVIEL**  
 KP 427/12  
 12,0 cm/4¾"  
 3 x 14 mm

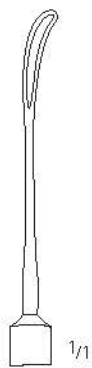

**SNELLEN**  
 KP 440/13  
 13,0 cm/5"

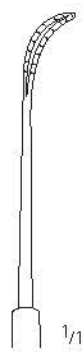

**ARLT**  
 KP 442/13  
 13,0 cm/5"

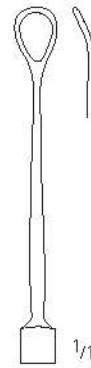

**LEWIS**  
 13,0 cm/5"  
 KP 443/01      KP  
 443/02  
 4,0 mm      4,7 mm

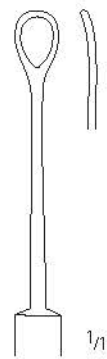

**NEW ORLEANS**  
 KP 450/13  
 13,0 cm/5"

Positionsspatel, Linsenkernspatel  
 Lens Spatulas, Nucleus Spatulas  
 Espátulas para manipular, Espátulas para núcleo cristalino  
 Spatules pour manipuler, Spatules pour noyau  
 Spatole per manipolare, Spatole per nucleo cristallino

AA

AB

AC

AD

AE

AK

AR

KA

KM

KO

KP

XR

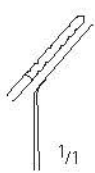

**JAFFE**  
 KP 470/12  
 12,0 cm / 4<sup>3</sup>/<sub>4</sub>"  
 0,5 mm



**OBSTBAUM**  
 KP 471/12  
 12,0 cm / 4<sup>3</sup>/<sub>4</sub>"  
 0,25 mm

**TITANIUM**



1/1

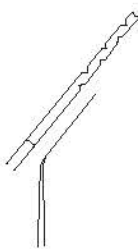

**HIRSCHMANN**  
 KP 472/13  
 12,5 cm / 5"

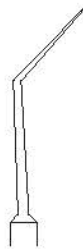

**MOD. DORTMUND**  
 KP 478/12  
 12,0 cm / 4<sup>3</sup>/<sub>4</sub>"  
 0,6 x 12 mm



1/1

**KNOLLE**  
 KP 480/13  
 12,5 cm / 5"



1/1

**LIPPMAN**  
 KP 481/12  
 12,0 cm / 4<sup>3</sup>/<sub>4</sub>"

Zyklodialysespatel  
 Cycdialysis Spatulas  
 Espátulas para cidodiálisis  
 Spatules à cyclodialyse  
 Spatole per cidodialisi

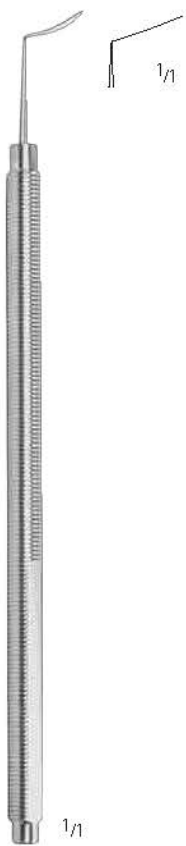

**CASTROVIEJO-BARRAQUER**  
 KP 485/11  
 11,0 cm/4 1/2"  
 0,5 x 10 mm

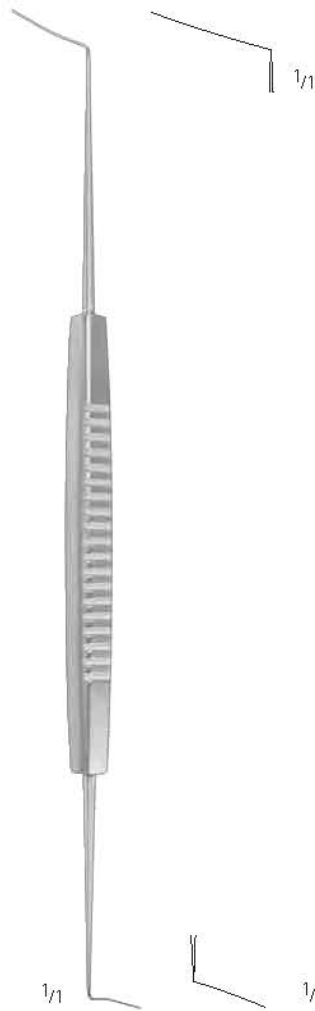

**CASTROVIEJO**  
 KP 487/14  
 13,5 cm/5 1/4"  
 0,5 x 10/16 mm

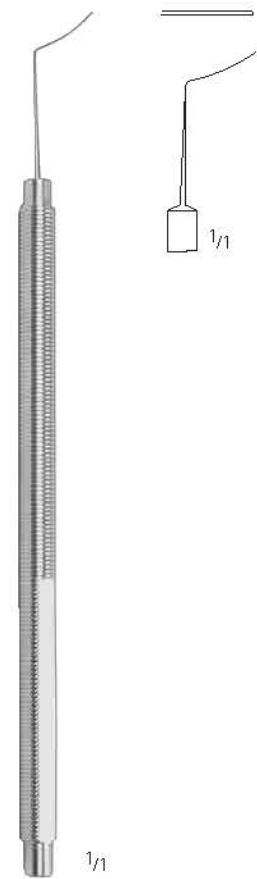

**BARRAQUER-FINO**  
 KP 489/12  
 11,5 cm/4 1/2"  
 0,25 x 12 mm

Irisspatel  
Iris Spatulas  
Espátulas para iris  
Spatules à iris  
Spatole per l'iride

AA

AB

AC

AD

## TITANIUM

AE

AK

AR

KA

KM

KO

KP

XR



biegsam  
malleable  
maleable  
malléable  
malleabile

**WECKER**  
KP 495/13  
13,0 cm/5"  
2 mm

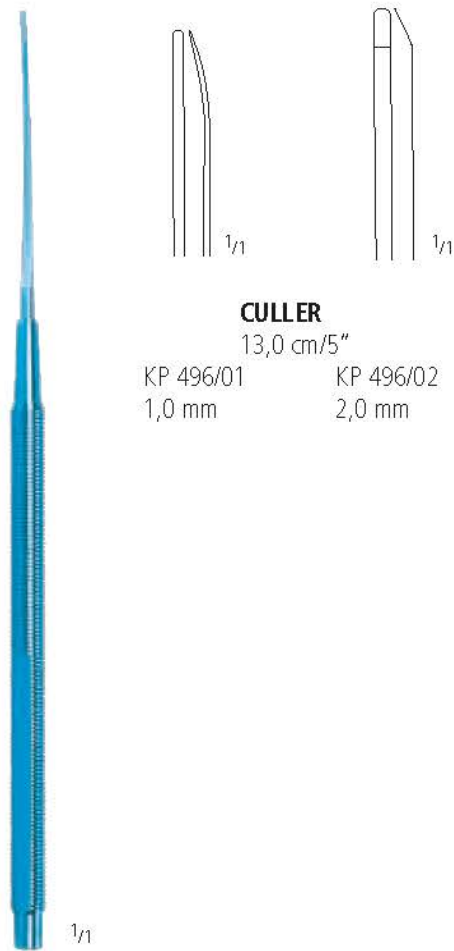

**CULLER**

13,0 cm/5"

KP 496/01  
1,0 mm

KP 496/02  
2,0 mm

Markierinstrumente optisches Zentrum, Radial- und Axialmarkierinstrumente  
 Optical Zone Markers, Radial and Axis Markers  
 Marcadores para centro óptico, Marcadores radiales y axiales  
 Marqueurs pour centre optique, Marqueurs radiales et axiales  
 Marcatori ottici, Marcatori radiali e assiali

## TITANIUM

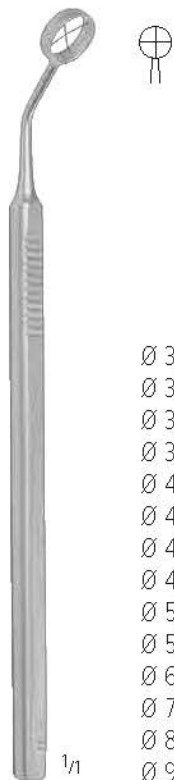

- Ø 3,00 mm KP 500/30
- Ø 3,25 mm KP 500/32
- Ø 3,50 mm KP 500/35
- Ø 3,75 mm KP 500/37
- Ø 4,00 mm KP 500/40
- Ø 4,25 mm KP 500/42
- Ø 4,50 mm KP 500/45
- Ø 4,75 mm KP 500/47
- Ø 5,00 mm KP 500/50
- Ø 5,50 mm KP 500/55
- Ø 6,00 mm KP 500/60
- Ø 7,00 mm KP 500/70
- Ø 8,00 mm KP 500/80
- Ø 9,00 mm KP 500/90

**HOFFER**  
10,0 cm/4"

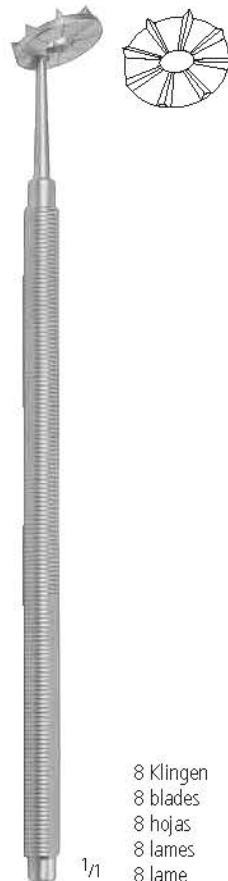

- 8 Klingen
- 8 blades
- 8 hojas
- 8 lames
- 8 lame

**ANIS**  
KP 505/12  
12,0 cm/4<sup>3</sup>/<sub>4</sub>"  
Ø 4 mm/12,5 mm

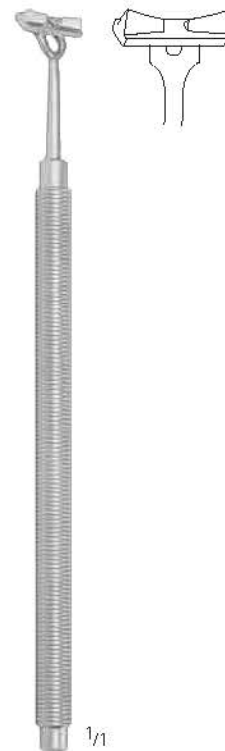

**BORES**  
KP 508/10  
10,0 cm/4"



**GRANDON**  
KP 510/11  
11,0 cm/4<sup>1</sup>/<sub>2</sub>"  
3 mm

Hornhautmarkierinstrumente  
 Corneal Markers  
 Marcadores corneales  
 Marqueurs cornéens  
 Marcatori corneali

AA

AB

AC

AD

AE

AK

AR

KA

KM

KO

KP

XR

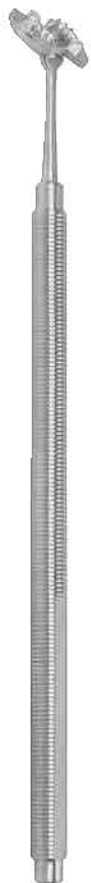

1/1

**LINDSTROM**  
 KP 515/12  
 12,0 cm/4<sup>3</sup>/<sub>4</sub>"  
 7 mm



1/1

**LU**  
 KP 516/11  
 10,5 cm/4<sup>1</sup>/<sub>4</sub>"  
 Ø 8,5 mm

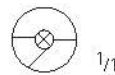

1/1



1/1

KP 518/10  
 10,0 cm/4"

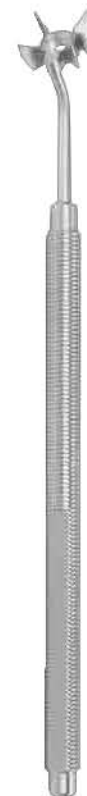

1/1

KP 519/10  
 10,0 cm/4"  
 Ø 5 + 11 mm

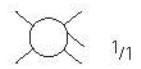

1/1

4+1 Klengen  
 4+1 blades  
 4+1 hojas  
 4+1 lames  
 4+1 lame



Hornhaut-, Limbus Inzisions-, Nahtplatzierungsmarkierinstrumente  
 Corneal Markers, Limbal Incision Rulers, Suture Placement Markers  
 Marcadores corneales, para incisión limbal y para suturas  
 Marqueurs pour kéroplastie, pour incision limbique et à sutures  
 Marcatori corneali, per incisione in limbo e per sutura

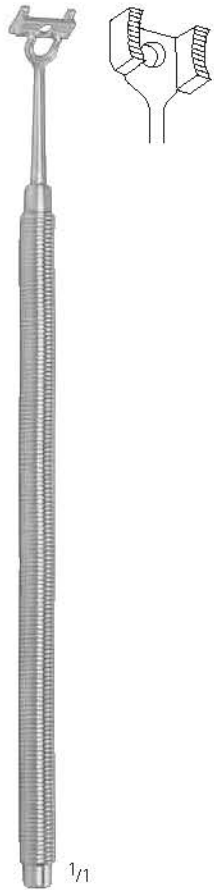

**THORNTON**  
 KP 523/12  
 12,0 cm/4<sup>3</sup>/<sub>4</sub>"  
 6-8 mm / 0,5-5,0 mm

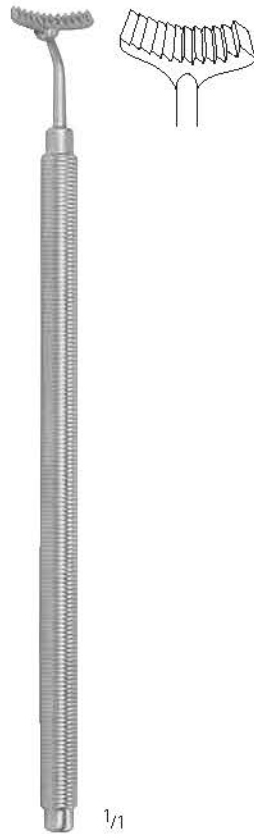

**THORNTON**  
 KP 530/11  
 11,0 cm/4<sup>1</sup>/<sub>2</sub>"  
 1-10 mm

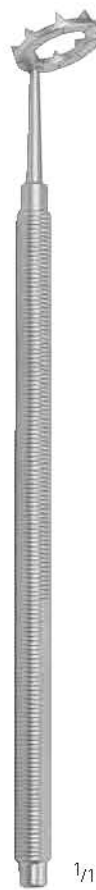

**ANIS**  
 KP 535/12  
 12,0 cm/4<sup>3</sup>/<sub>4</sub>"



**GONNIN**  
 KP 540/13  
 13,0 cm/5"  
 11-23 mm / 1 mm

Tonometer, Keratometer  
 Tonometers, Keratometer  
 Tonómetros, Queratómetro  
 Tonomètres, Kératomètre  
 Tonometri, Cheratometro



**SCHIOETZ**  
 13,0 cm/5"

gerade Skala  
 straight scale  
 graduado recto  
 échelle droite  
 scala retta

schräge Skala  
 inclined scale  
 graduado inclinado  
 échelle oblique  
 scala inclinata

Spezifikation Nr. 3  
 Specification No. 3  
 Especificación No. 3  
 Spécification No. 3  
 Specifica No. 3

KP 543/00

Spezifikation Nr. 5, geeicht  
 Specification No. 5, calibrated  
 Especificación No. 5, calibrada  
 Spécification No. 5, calibrée  
 Specifica No. 5, calibrata

KP 542/01

KP 543/01



1/1

**MALONEY**  
 KP 545/02  
 2,0 cm/3/4"

AA  
 AB  
 AC  
 AD  
 AE  
 AK  
 AR  
 KA  
 KM  
 KO  
 KP  
 XR

Messinstrumente, Tiefenlehre, Fixierringe  
 Measuring Instruments, Depth Gauge, Fixation Rings  
 Instrumentos de medición, Medidor de profundidad, Anillos de fijación  
 Instruments de mesure, Jauge de profondeur, Anneaux de fixation  
 Strumenti per la misurazione, Misuratori di profondità, Anelli di fissazione



**MENDEZ**  
 KP 547/11  
 11,0 cm/4 1/2"  
 C 10°, 0 -180°

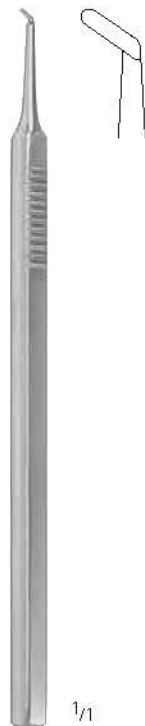

**DEITZ**  
 9,5 cm/3 3/4"  
 KP 548/50      KP 548/55  
 0,50 mm      0,55 mm

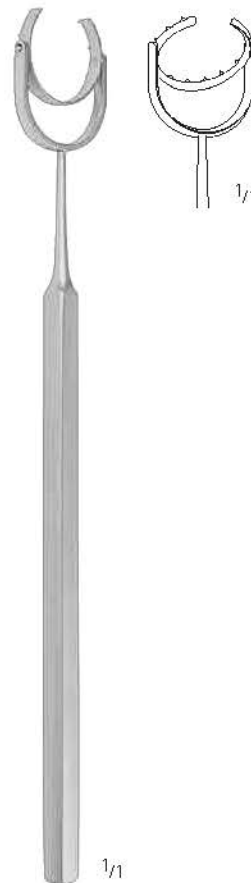

**THORNTON**  
 KP 550/12  
 12,0 cm/4 3/4"  
 Ø 13 mm

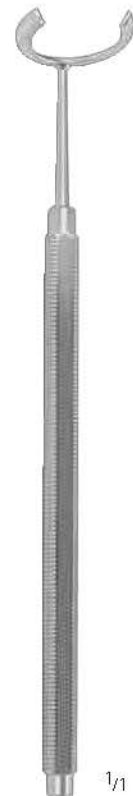

**BONN**  
 KP 555/11  
 10,5 cm/4 1/4"

Hornhautbohrer und -trephinen  
 Corneal Burrs and Trephines  
 Fresas y trépanos corneales  
 Trépanos kératoplastie  
 Trepani corneali

AA

AB

AC

AD

AE

AK

AR

KA

KM

KO

KP

XR



1/1

mm Ø

5,0	KP 600/50
5,5	KP 600/55
6,0	KP 600/60
6,5	KP 600/65
7,0	KP 600/70
7,5	KP 600/75
8,0	KP 600/80
9,0	KP 600/90

**CASTROVIEJO**

5,0 cm/2"



1/1

mm Ø

7,0	KP 603/70
7,1	KP 603/71
8,0	KP 603/80
8,1	KP 603/81

**FRANCESCHETTI**

7,5 cm/3"



1/1

mm Ø

5,0	KP 605/50
5,5	KP 605/55
6,0	KP 605/60
6,5	KP 605/65
6,7	KP 605/67
7,0	KP 605/70
7,2	KP 605/72
7,5	KP 605/75

mm Ø

7,7	KP 605/77
8,0	KP 605/80
8,2	KP 605/82
8,5	KP 605/85
8,7	KP 605/87
9,0	KP 605/90
9,5	KP 605/95

**MARTIN**

4,0 cm/1 1/2"

Hornhautbohrer und -trephinen  
 Corneal Burrs and Trephines  
 Fresas y trépanos corneales  
 Trépan<sup>s</sup> kératoplastie  
 Trepani corneali



**ELLIOT**  
 KP 611/00  
 3,0 cm/1 1/4"



**ELLIOT**  
 KP 612/10  
 Ø 1,0 mm



**ELLIOT**  
 KP 612/15    KP 612/20  
 Ø 1,5 mm    Ø 2,0 mm

**ELLIOT SET**

KP 610/00 = KP 611/00  
 KP 612/10  
 KP 612/15  
 KP 612/20

mit Etui  
 with case  
 con estuche  
 avec boîte  
 con scatola



**STORZ**  
 KP 620/08  
 8,0 cm/3 1/4"

mit 6 Fräsen  
 with 6 burrs  
 con 6 fresas  
 avec 6 fraises  
 con 6 fresas

Rostringfräse, Fixierringe,  
Rust Ring Remover, Scleral Fixation Rings  
Anillo removedor de óxido, Anillos de fijación  
Fraise pour enlever la rouille, Anneaux de fixation  
Fresa corneale, Anelli di fissazione



**RUST RING  
REMOVER SET**

KP 630/00  
12,5 cm/5"



KP 631/00  
6 Fräsen  
6 burrs  
6 fresas  
6 fraises  
6 fresas

KP 632/00  
Batterie, 2 Stück  
Battery, 2 pieces  
bateria, 2 piezas  
pile, 2 pièces  
pile, 2 pezzi

KP 630/00 = KP 631/00 + KP 632/00



**FLIERINGA**

mm Ø	
14	KP 640/14
16	KP 640/16
18	KP 640/18
20	KP 640/20
22	KP 640/22
24	KP 640/24

AA

AB

AC

AD

AE

AK

AR

KA

KM

KO

KP

XR



Vorderkammerspülkanülen, Silikonball, Verbindung, Spülkanülen  
 Anterior Chamber Irrigation Cannula, Silicon Ball, Connection, Irrigation Cannulas  
 Cánulas de irrigación para cámara anterior, Pelota de silicona, Conector, Cánulas para irrigación  
 Canules à lavage pour chambre antérieure, Balle de silicone, Raccord, Canules irrigatrices  
 Cannule d'irrigazione per camera anteriore, Palla di silicone, Raccordo, Cannule d'irrigazione

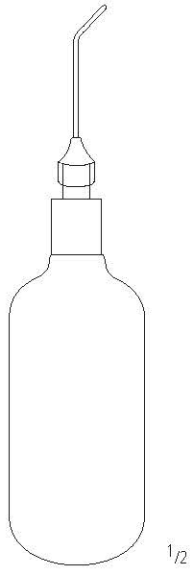

**BISHOP-HARMON**  
 KP 700/00

Set komplett  
 Set complete  
 Juego completo  
 Jeu complet  
 Set completo

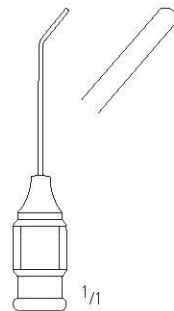

**BISHOP-HARMON**  
 KP 701/19  
 4,0 cm/1 1/2"  
 19G

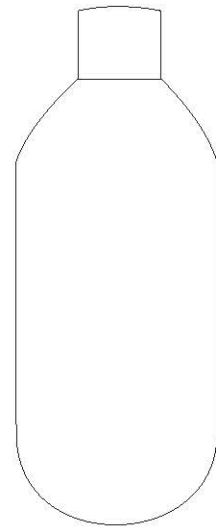

KP 702/00  
 7,5 cm/2 3/4"

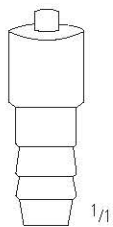

**LUER-LOCK**  
 KP 703/00  
 3,0 cm/1 1/4"

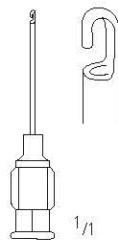

**McINTYRE**  
 KP 704/23  
 3,0 cm/1 1/4"  
 23G

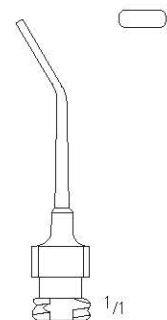

**MODELL BONN**  
 4,0 cm/1 1/2"  
 KP 705/19      KP 705/20  
 19G                      20G

OPHTHALMOLOGIE OPHTHALMOLOGY OFTALMOLOGIA OPHTALMOLOGIE OFTALMOLOGIA

Vorderkammer-, Saug- und Spülkanülen, Luftkanülen  
 Anterior Chamber, Irrigation and Aspiration Cannulas, Air Injection Cannulas  
 Cánulas para cámara anterior, irrigación y aspiración, Cánulas para inyectar aire  
 Canules à chambre antérieure, irrigatrices et pour aspiration, Canules à injection d'air  
 Cannule per camera anteriore, d'irrigazione e d'aspirazione, Cannule per iniettare aria

AA  
AB  
AC  
AD  
AE  
AK  
AR  
KA  
KM  
KO  
KP  
XR

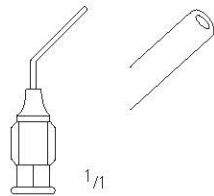

**McINTYRE**  
 2,5 cm/1"  
 KP 712/27    KP 712/30  
 27G         30G

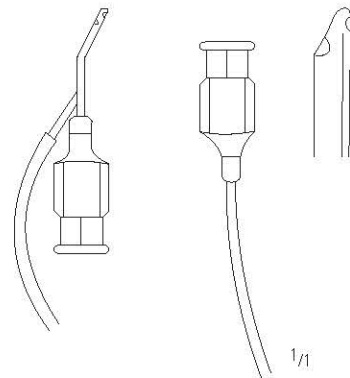

**SIMCOE**  
 KP 720/23  
 3,0 cm/1 1/4"  
 25/23G

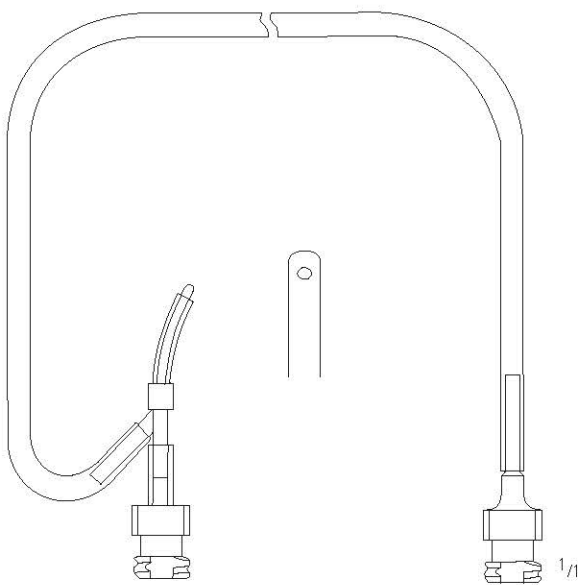

**FRIEDBURG**  
 KP 721/00  
 4,0 cm/1 1/2"                      3,0 cm/1 1/4"

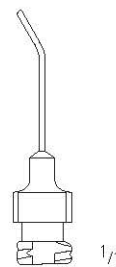

**SAUTTER**  
 KP 730/27    KP 730/30  
 27G         30G

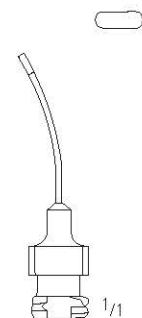

**SAUTTER**  
 KP 731/27  
 3,5 cm/1 1/2"  
 27G

Tränenwegkanülen, Kortex Extraktor  
 Lacrimal Cannulas, Cortex Extractor  
 Cánulas lacrimales, Extractor para corteza  
 Canules à voies lacrymales, Extracteur de cortex  
 Cannules per vie lacrimali, Estrattore per capsula

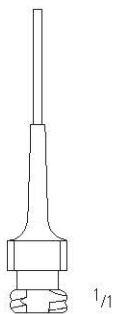

**ANEL**  
 KP 740/23  
 4,0 cm/1 1/2"  
 23G

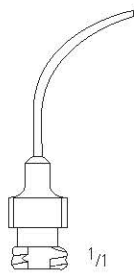

KP 741/23  
 3,5 cm/1 1/2"  
 23G

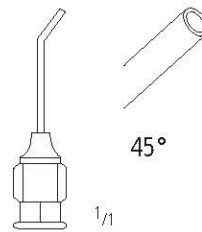

**GILLS-WELSH**  
 KP 745/25  
 3,0 cm/1 1/4"  
 25G

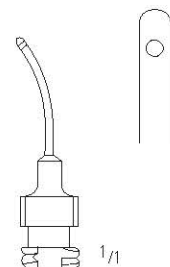

**SIMCOE**  
 KP 746/23  
 3,0 cm/1 1/4"  
 23G

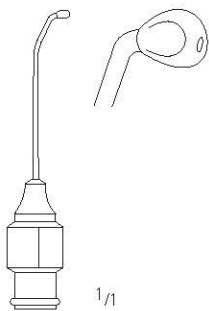

**WELSH**  
 KP 747/00  
 4,0 cm/1 1/2"  
 25G

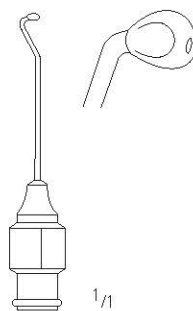

**WELSH**  
 KP 747/01  
 4,0 cm/1 1/2"  
 25G

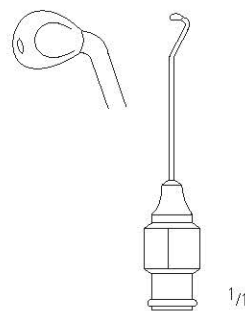

**WELSH**  
 KP 747/02  
 4,0 cm/1 1/2"  
 25G

Linsenschlinge und Linsenkerenschlinge mit Spülung, Injektionskanüle  
 Lens Loop and Lens Nucleus Loop with Irrigation, Injection Cannula  
 Asas para cristalino y Cánula para núcleo con irrigación, Cánula para inyección  
 Anses à cristallin et Canula du noyau avec irrigation, Canule à injection  
 Anse per cristallino con irrigazione, Irrigatore per lenti intraoculari, Cannula per lavaggio

AA  
AB  
AC  
AD  
AE  
AK  
AR  
KA  
KM  
KO  
KP  
XR

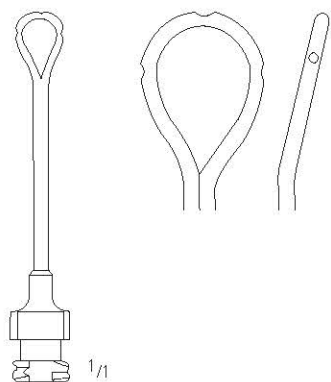

**KNOLLE-PEARCE**  
 KP 755/23  
 5,0 cm/2"  
 23G

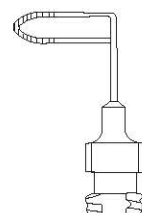
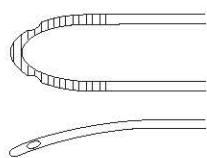

KP 756/01  
 25G

**SIMCOE**  
 3,0 cm/1 1/4"

KP 756/02  
 25G

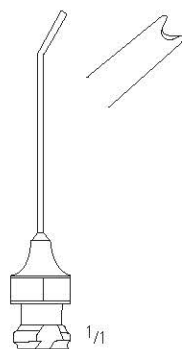

KP 760/21  
 4,5 cm/2"  
 21G

Kapselpolierer, Kapselpeile, Kapselsauger  
 Capsule Polisher, Capsule Scraper, Erisiphake  
 Pulidor para cápsula, Erisiphake  
 Canule gratteuse, Erisiphaque capsulaire  
 Levigatore corneale, Aspiratore capsulare

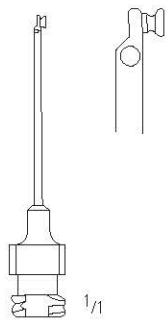

KP 763/01  
23G

**GRAETHER**  
4,0 cm/1 1/2"

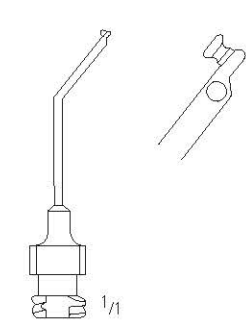

KP 763/02  
23G

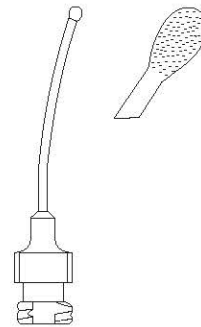

**JENSEN**  
KP 767/27  
4,5 cm/2"  
27G

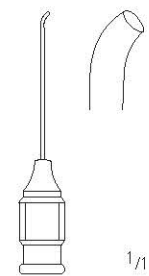

KP 768/23  
23G

**KNOLLE**  
3,5 cm/1 1/2"

KP 768/30  
30G

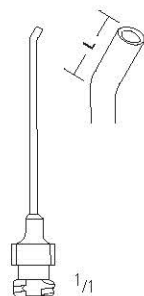

KP 772/01  
23G  
L = 1 mm

**KRATZ**  
3,5 cm/1 1/2"

KP 772/02  
23G  
L = 2 mm

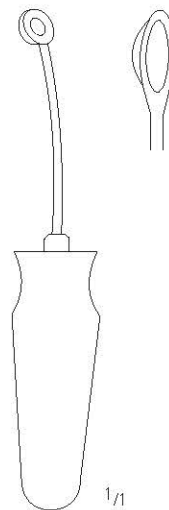

**BELL**  
KP 775/00  
6,5 cm/2 1/2"

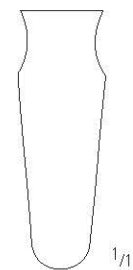

**BELL**  
KP 775/01

Zyklodialysen-, Alpha-Chymotrypsin- und Zystotomkanüle  
 Cyclodialysis-, Alpha-Chymotrypsin- and Cystotome Cannula  
 Cánula para ciclodialísis, Alpha-Chymotrypsin y cistótomo  
 Canule pour cyclodialyse, à injection Alpha-Chimo-Trypsine et cystotome  
 Cannule per ciclodialisi, per alfa-chimotripsina e per cistotomi

AA

AB

AC

AD

AE

AK

AR

KA

KM

KO

KP

XR

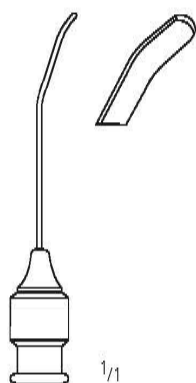

**KELMAN**  
4,0 cm//1 1/2"

KP 780/01  
19G

KP 780/02  
19G

rechts  
right  
derecho  
droit

links  
left  
izquierda  
gauche  
sinistro

destro

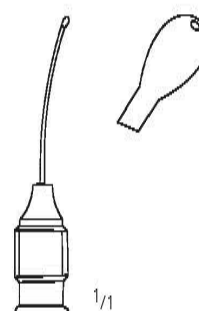

**TROUTMAN**

KP 783/25  
4,5 cm//2"

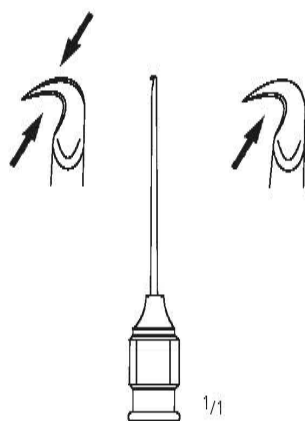

**KELMAN**  
4,5 cm//2"

KP 786/00  
22G

KP 786/01  
22G

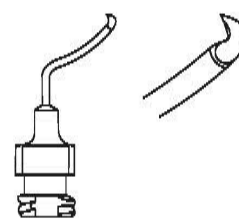

**KRATZ**

KP 788/22  
3,0 cm//1 1/4"  
22G



Augennadeln  
Eye Needles  
Agujas oculares  
Aiguilles ophtalmiques  
Aghi oftalmichi

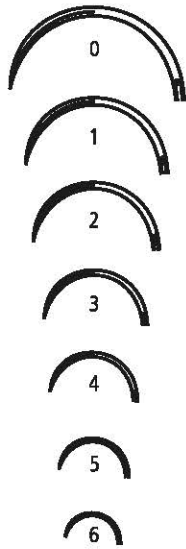

**OG**

gebogen 1/2 Kreis  
curved 1/2 circle  
curvas 1/2 círculo  
coubes 1/2 cercle  
curvi 1/2 círculo



gewöhnliches Ohr  
regular eye  
ojo ordinario  
chas régulier  
cruna ordinaria

- KP 950/00
- KP 950/01
- KP 950/02
- KP 950/03
- KP 950/04
- KP 950/05
- KP 950/06



Federöhr  
spring eye  
ojo de resorte  
chas à ressort  
cruna a molla

- KP 951/00
- KP 951/01
- KP 951/02
- KP 951/03
- KP 951/04
- KP 951/05
- KP 951/06

- FIG. 0**
- FIG. 1**
- FIG. 2**
- FIG. 3**
- FIG. 4**
- FIG. 5**
- FIG. 6**

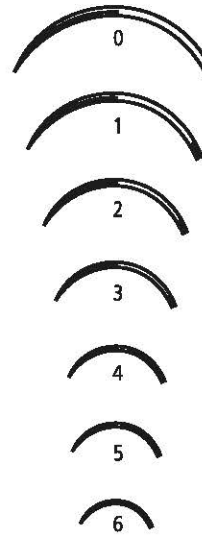

**OB**

gebogen 3/8 Kreis  
curved 3/8 circle  
curvas 3/8 círculo  
coubes 3/8 cercle  
curvi 3/8 círculo



gewöhnliches Ohr  
regular eye  
ojo ordinario  
chas régulier  
cruna ordinaria

- KP 952/00
- KP 952/01
- KP 952/02
- KP 952/03
- KP 952/04
- KP 952/05
- KP 952/06



Federöhr  
spring eye  
ojo de resorte  
chas à ressort  
cruna a molla

- KP 953/00
- KP 953/01
- KP 953/02
- KP 953/03
- KP 953/04
- KP 953/05
- KP 953/06

Verkaufseinheit 1 Dutzend  
unit for sale 1 dozen  
unidad de venta 1 docena  
unité d' 1 douzaine  
unità di vendita 1 dozzina

Augenklappen, Pinsel  
 Eye Patches, Brushes  
 Protectores de ojos, Pincel  
 Bandeaux pour les yeux, Pinceau  
 Benda di protezione per gli occhi, Pennello

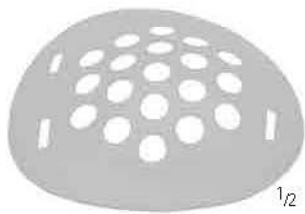

KP 955/01



KP 955/02



KP 956/00



**BARRAQUER**  
 KP 959/00

AA  
 AB  
 AC  
 AD  
 AE  
 AK  
 AR  
 KA  
 KM  
 KO  
 KP  
 XR



HF-ZUBEHÖR  
HF-ACCESSORIES  
AF-ACCESORIOS  
HF-ACCESSOIRES  
AF-ACCESSORI

**XR**

**nopa**<sup>®</sup> instruments





Anschlußkabel, Bi-Koagulations-Pinzetten  
 Connection Cords, Bi-Coagulation-Forceps  
 Cables de conexión, Pinzas para Coagulación  
 Câbles de raccordement, Pincas pour Bi-Coagulation  
 Cavi da connessione, Pinze per la Bi-Coagulazione

AA  
AB  
AC  
AD  
AE  
AK  
AR  
KA  
KM  
KO  
KP  
XR

bipolar



**MARTIN / BERCHTHOLD**

300 cm XR 830/03  
 500 cm XR 830/05

bipolar



**ERBE/SELECT**

XR 832/03  
 XR 832/05

D=0,5 mm

E=Nadel



11,0 cm/4 <sup>1</sup> / <sub>3</sub> "	XR 898/11 D	XR 899/11 D
11,0 cm/4 <sup>1</sup> / <sub>3</sub> "	XR 898/11 E	XR 899/11 E



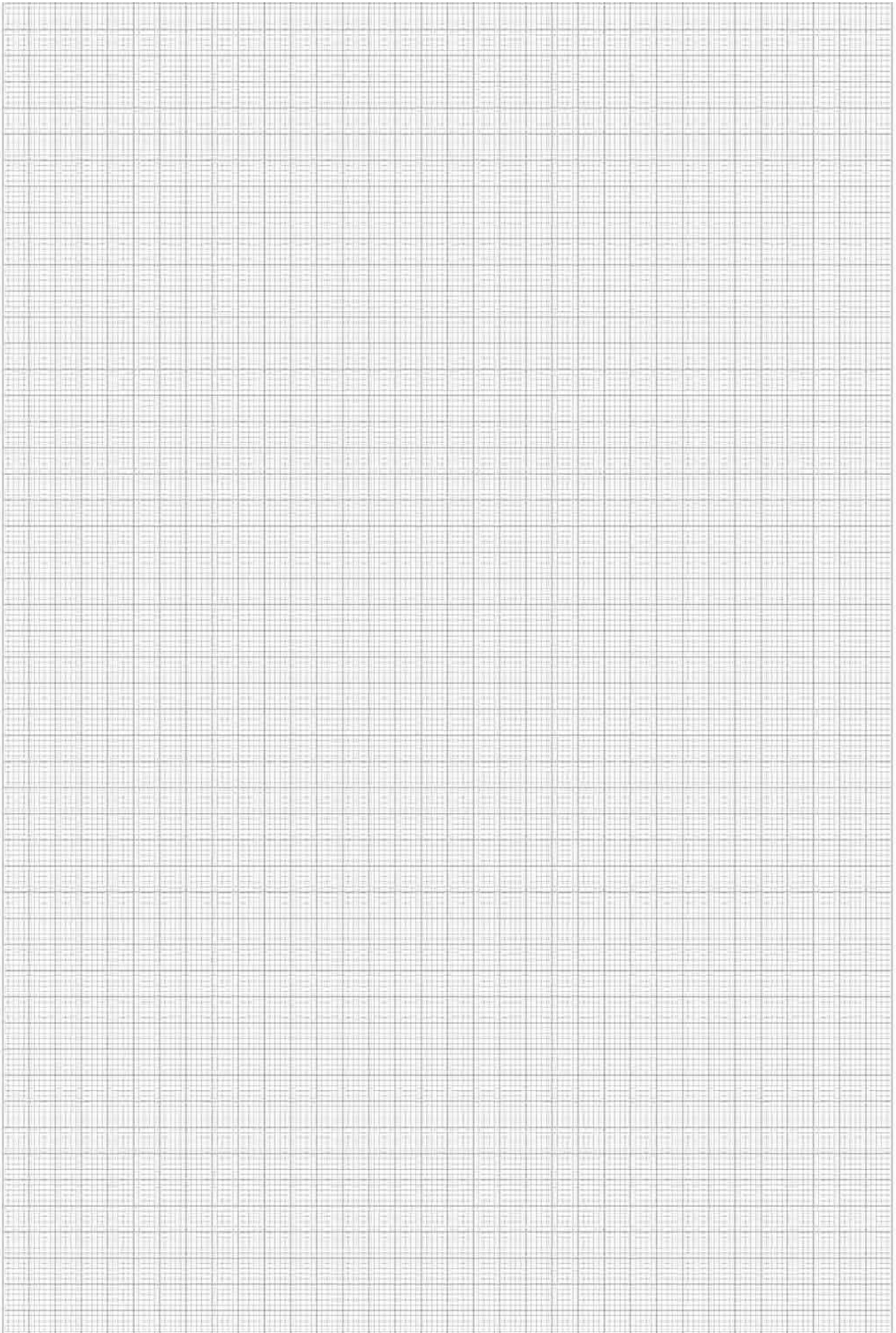

**nopa**<sup>®</sup> instruments

**nopa instruments**

Medizintechnik GmbH

Weilatten 7-9

D - 78532 Tuttlingen

Tel. +49.7462.9490-0

Fax +49.7462.9490-90

info@nopa.de

www.nopa.de

Herstellung und Verkauf chirurgischer  
und endoskopischer Instrumente.

Manufacture and Sales of Surgical  
and Endoscopic Instruments.

